

User Manual

3-Phase Hybrid Inverter

SH5T/6T/8T/10T/12T/15T/20T/25T



All Rights Reserved

All Rights Reserved

No part of this document can be reproduced in any form or by any means without the prior written permission of Sungrow Power Supply Co., Ltd (hereinafter "SUNGROW").

Trademarks

SUNGROW and other Sungrow trademarks used in this manual are owned by SUNGROW.

All other trademarks or registered trademarks mentioned in this manual are owned by their respective owners.

Software Licenses

- It is prohibited to use data contained in firmware or software developed by SUNGROW, in part or in full, for commercial purposes by any means.
- It is prohibited to perform reverse engineering, cracking, or any other operations that compromise the original program design of the software developed by SUNGROW.

About This Manual

The manual mainly contains the product information, as well as guidelines for installation, operation, and maintenance. The manual does not include complete information about the photovoltaic (PV) system. Readers can get additional information at www.sungrowpower.com or on the webpage of the respective component manufacturer.

Validity

This manual is valid for the following model of low-power grid-connected PV string inverters:

- SH5T
- SH6T
- SH8T
- SH10T
- SH12T
- SH15T
- SH20T
- SH25T

It will be referred to as "inverter" hereinafter unless otherwise specified.

Target Group

This manual is intended for professional technicians who are responsible for installation, operation, and maintenance of inverters, and users who need to check inverter parameters.

The inverter must only be installed by professional technicians. The professional technician is required to meet the following requirements:

- Know electronic, electrical wiring and mechanical expertise, and be familiar with electrical and mechanical schematics.
- Have received professional training related to the installation and commissioning of electrical equipment.
- Be able to quickly respond to hazards or emergencies that occur during installation and commissioning.
- Be familiar with local standards and relevant safety regulations of electrical systems.
- Read this manual thoroughly and understand the safety instructions related to operations.

How to Use This Manual

Please read this manual carefully before using the product and keep it properly at a place for easy access.

All contents, pictures, marks, and symbols in this manual are owned by SUNGROW. No part of this document may be reprinted by the non-internal staff of SUNGROW without written authorization.

Contents of this manual may be periodically updated or revised, and the actual product purchased shall prevail. Users can obtain the latest manual from support.sungrowpower.com or sales channels.

Symbols

This manual contains important safety instructions, which are highlighted with the following symbols, to ensure personal and property safety during usage, or to help optimize the product performance in an efficient way.

Please carefully understand the meaning of these warning symbols to better use the manual.

DANGER

Indicates high-risk potential hazards that, if not avoided, may lead to death or serious injury.

WARNING

Indicates moderate-risk potential hazards that, if not avoided, may lead to death or serious injury.

CAUTION

Indicates low-risk potential hazards that, if not avoided, may lead to minor or moderate injury.

NOTICE

Indicates potential risks that, if not avoided, may lead to device malfunctions or financial losses.



“NOTE” indicates additional information, emphasized contents or tips that may be helpful, e.g., to help you solve problems or save time.

Contents

All Rights Reserved	I
About This Manual	II
1 Safety Instructions	1
1.1 Unpacking and Inspection	2
1.2 Installation Safety	3
1.3 Electrical Connection Safety	3
1.4 Operation Safety	6
1.5 Maintenance Safety	6
1.6 Disposal Safety	7
2 Product Description	8
2.1 System Introduction	8
2.2 Product Introduction	8
2.3 Symbols on the Product	10
2.4 LED Indicator	11
2.5 PV Energy Storage System (PV ESS)	12
2.5.1 PV ESS Introduction	12
2.5.2 Declaration For Backup Function	13
2.5.3 Energy Management	14
2.6 Parallel System	16
2.6.1 Grid-connected Parallel System	16
2.7 Retrofitting the Existing PV System	17
2.8 Whole Home Backup	18
3 Function Description	20
3.1 Safety Function	20
3.1.1 Protection	20
3.1.2 Earth Fault Alarm	20
3.2 Energy Conversion and Management	20
3.2.1 Power Derating	20
3.2.2 DRM (“AU”/“NZ”)	20
3.2.3 Regular Operational Voltage Range	21
3.2.4 Regular Operational Frequency Range	21

3.2.5	Reactive Power Regulation	22
3.2.6	Load Control	22
3.3	Battery Management	22
3.3.1	Charge Management	23
3.3.2	Discharge Management	24
3.4	Communication and Configuration	25
4	Unpacking and Storage	26
4.1	Unpacking and Inspection	26
4.2	Scope of Delivery	27
4.3	Inverter Storage	28
5	Mechanical Mounting	29
5.1	Safety During Mounting	29
5.2	Location Requirements	30
5.2.1	Installation Environment Requirements	30
5.2.2	Carrier Requirements	31
5.2.3	Angle Requirements	31
5.2.4	Clearance Requirements	32
5.3	Installation Tools	33
5.4	Moving the Inverter	34
5.5	Installing the Inverter	34
6	Electrical Connection	37
6.1	Safety Instructions	37
6.2	Terminal Description	38
6.3	Electrical Connection Overview	41
6.4	External Protective Grounding Connection	50
6.4.1	External Protective Grounding Requirements	51
6.4.2	Connection Procedure	51
6.5	AC Cable Connection	52
6.5.1	AC Side Requirements	52
6.5.2	Installing the AC Connector	52
6.6	DC Cable Connection	56
6.6.1	PV Input Configuration	57
6.6.2	Installing the PV Connectors	59
6.7	Battery Power Connection	61
6.7.1	Battery Connection Requirements	61
6.7.2	Installing the Battery Connector	62

6.8 Communication Connection	63
6.8.1 WiNet-S2 Connection	64
6.8.2 COM2 Terminal Communication Connection	66
6.9 Protective Cover Installation (Optional)	78
7 Commissioning/Startup Procedure	81
7.1 Inspection Before Commissioning	81
7.2 Commissioning Procedure	81
7.3 App Preparation	82
7.4 Creating a Plant.....	82
8 iSolarCloud App	93
8.1 Brief Introduction	93
8.2 Installing App	93
8.3 Account Registration.....	94
8.4 Login	95
8.4.1 Requirements	95
8.4.2 Login Procedure	95
8.5 Initial Settings.....	97
8.5.1 Feed-in Limitation	97
8.5.2 Backup Mode.....	97
8.5.3 Reactive Power Regulation Mode.....	97
8.6 Function Overview.....	100
8.7 Home	101
8.8 Run Information.....	102
8.9 Records.....	102
8.9.1 Chart.....	103
8.9.2 Fault Alarm Record	104
8.9.3 Event Records	104
8.10 More.....	105
8.10.1 System Parameters.....	105
8.10.2 Running Time	106
8.10.3 Fault Recovery.....	107
8.10.4 Regular Parameters	107
8.10.5 Off-grid Parameters.....	108
8.10.6 Active Power Regulation.....	108
8.10.7 Reactive Power Regulation.....	109
8.10.8 Battery Discharge Time	110

8.10.9 Battery Forced Charge Time	111
8.10.10 Load Control	112
8.10.11 Communication Parameters	113
8.10.12 Firmware Update.....	113
8.10.13 Grounding Detection.....	115
8.10.14 Parallel Configuration	115
8.10.15 Frequency Shift Power Control	116
8.10.16 Import Power Limit.....	116
8.10.17 Energy Management Mode	117
8.10.18 DO Configuration	118
9 System Decommissioning/Shutdown Procedure	120
9.1 Decommissioning the Inverter	120
9.1.1 Disconnect the Inverter.....	120
9.1.2 Dismantling the Inverter.....	120
9.1.3 Disposal of Inverter	121
9.2 Decommissioning the Battery	121
10 Troubleshooting and Maintenance	122
10.1 Troubleshooting.....	122
10.2 Maintenance	127
10.2.1 Maintenance Notices	127
10.2.2 Routine Maintenance.....	128
10.2.3 Replacing the Button Cell.....	129
11 Appendix	130
11.1 Technical Data	130
11.2 The Compatibility for Backup under Off-grid Scenario	140
11.3 Quality Assurance.....	141
11.4 Contact Information.....	142

1 Safety Instructions

When installing, commissioning, operating, and maintaining the product, strictly observe the labels on the product and the safety requirements in the manual. Incorrect operation or work may cause:

- Injury or death to the operator or a third party.
- Damage to the product and other properties.

WARNING

- **Do not perform any operation on the product (including but not limited to, handling, installing, powering on, or maintaining the product, performing electrical connection, and working at heights) in harsh weather conditions, such as thunder and lightning, rain, snow, and Level 6 or stronger winds. SUNGROW shall not be held liable for any damage to the device due to force majeure, such as earthquakes, floods, volcanic eruptions, mudslides, lightning strikes, fires, wars, armed conflicts, typhoons, hurricanes, tornadoes, and other extreme weathers.**
- **In case of fire, evacuate from the building or product area and call the fire alarm. Re-entry into the burning area is strictly prohibited under any circumstances.**

NOTICE

- **Tighten the screws with the specified torque using tools when fastening the product and terminals. Otherwise, the product may be damaged. And the damage caused is not covered by the warranty.**
- **Learn how to use tools correctly before using them to avoid hurting people or damaging the device.**
- **Maintain the device with sufficient knowledge of this manual and use proper tools.**



- The safety instructions in this manual are only supplements and cannot cover all the precautions that should be followed. Perform operations considering actual onsite conditions.
- SUNGROW shall not be held liable for any damage caused by violation of general safety operation requirements, general safety standards, or any safety instruction in this manual.
- When installing, operating, and maintaining the product, comply with local laws and regulations. The safety precautions in this manual are only supplements to local laws and regulations.
- During the product transport, installation, wiring, maintenance, etc., the materials and tools prepared by users must meet the requirements of applicable local laws and regulations, safety standards, and other specifications. SUNGROW shall not be held liable for any damage to the product caused by the adoption of materials and tools that fail to meet the above-mentioned requirements.
- Operations on the product, including but not limited to, handling, installing, wiring, powering on, maintenance, and use of the product, must not be performed by unqualified personnel. SUNGROW shall not be held liable for any damage to the product resulting from operations done by unqualified personnel.
- Where the transport of the product is arranged by users, SUNGROW shall not be held liable for any damage to the product that is caused by users themselves or the third-party transport service providers designated by the users.
- SUNGROW shall not be held liable for any damage to the product caused by the negligence, intent, fault, improper operation, and other behaviors of users or third-party organizations.
- SUNGROW shall not be held liable for any damage to the product arising from reasons unrelated to SUNGROW.

1.1 Unpacking and Inspection

WARNING

- **Check all safety signs, warning labels and nameplates on devices.**
- **The safety signs, warning labels and nameplates must be clearly visible and cannot be removed or covered before the device is decommissioned.**

NOTICE

After receiving the product, check whether the appearance and structural parts of the device are damaged, and check whether the packing list is consistent with the actual ordered product. If there are problems with the above inspection items, do not install the device and contact your distributor first. If the problem persists, contact SUNGROW in time.

1.2 Installation Safety

DANGER

- Make sure there is no electrical connection before installation.
- Before drilling, avoid the water and electricity wiring in the wall.

CAUTION

Improper installation may cause personal injury!

- If the product supports hoisting transport and is hoisted by hoisting tools, no one is allowed to stay under the product.
- When moving the product, be aware of the product weight and keep the balance to prevent it from tilting or falling.

NOTICE

Before operating the product, must check and ensure that tools to be used have been maintained regularly.

1.3 Electrical Connection Safety

DANGER

Before electrical connections, please make sure that the inverter is not damaged, otherwise it may cause danger!

Before electrical connections, please make sure that the inverter switch and all switches connected to the inverter are set to "OFF", otherwise electric shock may occur!

DANGER

The PV string will generate lethal high voltage when exposed to sunlight.

- Operators must wear proper personal protective equipment during electrical connections.
- Must ensure that cables are voltage-free with a measuring instrument before touching DC cables.
- Respect all safety instructions listed in relevant documents about PV strings.

 DANGER

Danger to life due to a high voltage inside the inverter!

- **Be sure to use special insulation tools during cable connections.**
- **Note and observe the warning labels on the product, and perform operations strictly following the safety instructions.**
- **Respect all safety instructions listed in this manual and other pertinent documents.**

 DANGER

If the battery is short-circuited, the instantaneous current will be excessively high and a large amount of energy will be released, which may cause fire and personal injury.

Disconnect the battery from all voltage sources prior to performing any work on the battery.

Lethal voltages are present at the battery terminals and cables connecting to the inverter. Severe injuries or death may occur if the cables and terminals in the inverter are touched.

Observe all safety information provided by the battery manufacturer.

 WARNING

Damage to the product caused by incorrect wiring is not covered by the warranty.

- **Electrical connection must be performed by professionals.**
- **Please use measuring devices with an appropriate range. Overvoltage can damage the measuring device and cause personal injury.**
- **All cables used in the PV generation system must be firmly attached, properly insulated, and adequately dimensioned.**
- **Do not damage the ground conductor. Do not operate the product in the absence of a properly installed ground conductor. Otherwise, it may cause personal injury or product damage.**

⚠ WARNING

Check the positive and negative polarity of the PV strings, and connect the PV connectors to corresponding terminals only after ensuring polarity correctness.

During the installation and operation of the inverter, please ensure that the positive or negative poles of PV strings do not short-circuit to the ground. Otherwise, an AC or DC short-circuit may occur, resulting in equipment damage. The damage caused by this is not covered by the warranty.

The interfaces of the battery in the system must be compatible with the inverter.

The entire battery voltage range must be completely within the permissible range of the inverter, and the battery voltage shall not exceed the maximum permissible DC input voltage of the inverter.

NOTICE

- **Comply with the safety instructions related to PV strings and the regulations related to the local grid.**
- **Install the external protective grounding cable first when performing electrical connection and remove the external protective grounding cable last when removing the inverter.**

1.4 Operation Safety

DANGER

When routing cables, ensure a distance of at least 30 mm between the cables and heat-generating components or areas to protect the insulation layer of cables from aging and damage.

When the product is working:

- Do not touch the product enclosure.
- It is strictly forbidden to plug and unplug any connector on the inverter.
- Do not touch any wiring terminal of the inverter. Otherwise, electric shock may occur.
- Do not disassemble any parts of the inverter. Otherwise, electric shock may occur.
- It is strictly forbidden to touch any hot parts of the inverter (such as the heat sink). Otherwise, it may cause burns.
- Do not connect or remove any battery. Otherwise, electric shock may occur.
- Do not connect or remove any PV string or any PV module in a string. Otherwise, electric shock may occur.
- If the inverter is equipped with a DC switch, do not operate it. Otherwise, it may cause device damage or personal injury.

1.5 Maintenance Safety

DANGER

Risk of inverter damage or personal injury due to incorrect service!

- Before maintenance, disconnect the AC circuit breaker on the grid side and then the DC switch. If a fault that may cause personal injury or device damage is found before maintenance, disconnect the AC circuit breaker and wait until the night before operating the DC switch. Otherwise, a fire inside the product or an explosion may occur, causing personal injuries.
- After the inverter is powered off for, measure the voltage and current with professional instrument. Only when there is no voltage nor current can operators who wear protective equipment operate and maintain the inverter.
- Even if the inverter is shut down, it may still be hot and cause burns. Wear protective gloves before operating the inverter after it cools down.

⚠ DANGER

Touching the power grid or the contact points and terminals on the inverter connected to the power grid may lead to electric shock!

- The power grid side may generate voltage. Always use a standard voltmeter to ensure that there is no voltage before touching.

⚠ CAUTION

To prevent misuse or accidents caused by unrelated personnel, post prominent warning signs or demarcate safety warning areas around the product.

NOTICE

- If the paint on the inverter enclosure falls or rusts, repair it in time. Otherwise, the inverter performance may be affected.
- Do not use cleaning agents to clean the inverter. Otherwise, the inverter may be damaged, and the loss caused is not covered by the warranty.
- As the inverter contains no parts that can be maintained, never open the enclosure of the inverter or replace any internal components without authorization. Otherwise, the loss caused is not covered by the warranty.
- Do not open the maintenance door in rainy or snowy weather. If it is inevitable, take proper protective measures to avoid the ingress of rainwater and snow into the maintenance compartment; otherwise, the product's operation may be affected.
- Before closing the maintenance door, check whether there is any object left inside the maintenance compartment, such as screws, tools, etc.
- It is recommended for users to use cable sheathing to protect the AC cable. If the cable sheathing is used, make sure it is positioned inside the maintenance compartment.

1.6 Disposal Safety

⚠ WARNING

Please scrap the product in accordance with relevant local regulations and standards to avoid property losses or casualties.

2 Product Description

2.1 System Introduction

⚠ WARNING

- The inverter must only be operated with PV strings with class II protection in accordance with IEC 61730, application class A. It is not allowed for the positive pole or the negative pole of the PV strings to be grounded. This can cause the inverter to be destroyed.
- Do not connect any local load between the inverter and the AC circuit breaker.

NOTICE

For the TT utility grid, the N line voltage to ground must be 30 V or less.
The inverter applies only to the scenarios described in this manual.

The three-phase hybrid inverters are applicable to both on-grid and off-grid PV systems. With the integrated Energy Management System (EMS), they can control and optimize the energy flow so as to increase the self-consumption of the system.

2.2 Product Introduction

Model Description

The model description is as follows (take SH25T as an example):

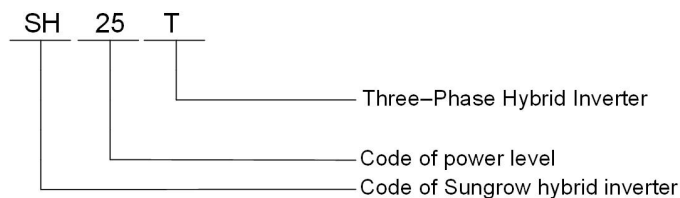

Appearance

The image shown here is for reference only. The actual product received may differ.

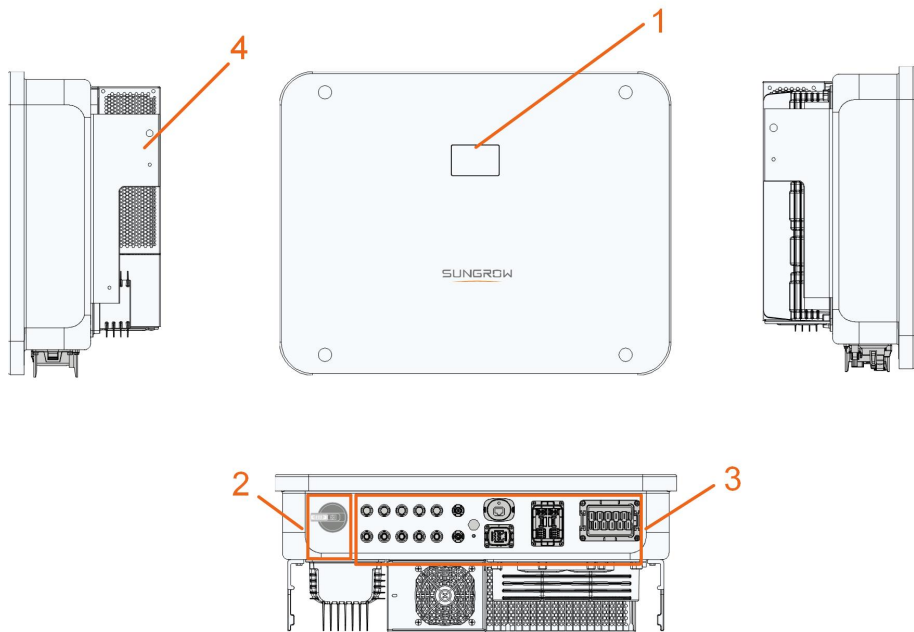

figure 2-1 Inverter Appearance

No.	Name	Description
1	LED indicator panel	Indicates the current working state of the inverter.
2	DC switch	Used to disconnect PV - only when there is no PV production.
3	Electrical connection area	Includes DC terminals, AC terminals, battery terminals, communication terminals and additional grounding terminal.
4	Hanger	Used to hang the inverter on the wall-mounting bracket.

Dimensions

The following figure shows the dimensions of the inverter.

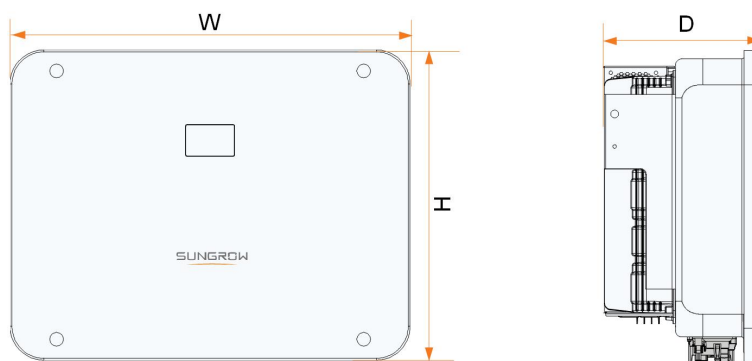









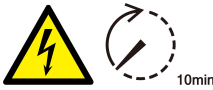



figure 2-2 Dimensions of the Inverter

Inverter	W(mm)	H(mm)	D(mm)	Weight(kg)
SH5/6/8/10/ 12T	620	480	195	32
SH15/20T	620	480	245	38
SH25T	620	480	245	40

2.3 Symbols on the Product

Symbol	Explanation
	RCM mark of conformity.
	TÜV mark of conformity.
	CE mark of conformity. EU/EEA Importer
	Do not dispose of the inverter together with household waste.
	The inverter does not have a transformer.
	Disconnect the inverter from all the external power sources before maintenance!
	Read the user manual before maintenance!
	Burn danger due to hot surface that may exceed 60°C.
	Danger to life due to high voltages! Only qualified personnel can open and service the inverter.

Symbol	Explanation
	Do not touch live parts for 10 minutes after disconnection from the power sources.
	Additional grounding point.

2.4 LED Indicator

The LED panel with a display screen and an indicator is on the front of the inverter.

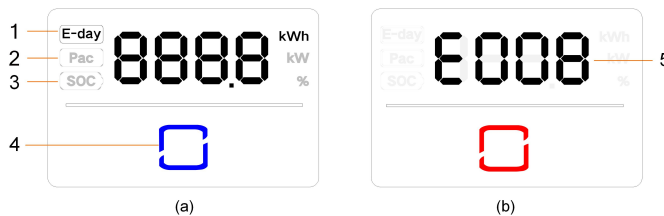

figure 2-3 LED Panel

(a) Normal state



(b) Error state

No.	Name	Description
1	E-day	Today's energy yield
2	Pac	Real-time AC output power
3	SOC	Battery SOC (State of Charge)
4	LED indicator	To indicate the working state of the inverter. Touch it to switch the information in normal state or view multiple error codes in error state.
5	Error code	The error code in the figure is just an example.

- In normal state, the E-day, Pac and SOC information will be displayed alternately. Also you can touch the LED indicator to switch the information.
- In error state, touch the LED indicator to view multiple error codes.
- If there is no operation for 5 minutes, the display screen will be off. Touch the LED indicator to activate it.

table 2-1 LED Indicator State Description

LED Color	state	Definition
 Blue	ON	The inverter is running in the on/off-grid mode.
	Blink	The inverter is at standby or startup state (without on/off-grid operation).

LED Color	state	Definition
 Red	ON	A system fault has occurred.
 Gray	OFF	Both the AC and DC sides are powered down.

⚠ WARNING

Voltage may still be present in AC side circuits after the indicator is off. Pay attention to the electricity safety when operating.

2.5 PV Energy Storage System (PV ESS)

NOTICE

When designing the system, ensure that the operating ranges of all devices that are connected to the inverter meet the requirements of the inverter.

2.5.1 PV ESS Introduction

By directly connecting a battery module to the inverter, the conventional PV system can be upgraded to be an Energy Storage System (ESS).

The system is capable of operating off-grid to ensure an emergency power supply for protected loads in the event of a grid interruption or blackout, which may be caused by:

- islanding;
- under-voltage;
- under-frequency or over-frequency.

NOTICE

- **Under any connection, either grid-connection or off-grid application, please be sure that the potential voltage between N and PE line is not higher than 30V, otherwise, inverter will stop generating power.**
- **The system is not suitable for supplying life-sustaining medical devices. It cannot guarantee backup power in all circumstances.**

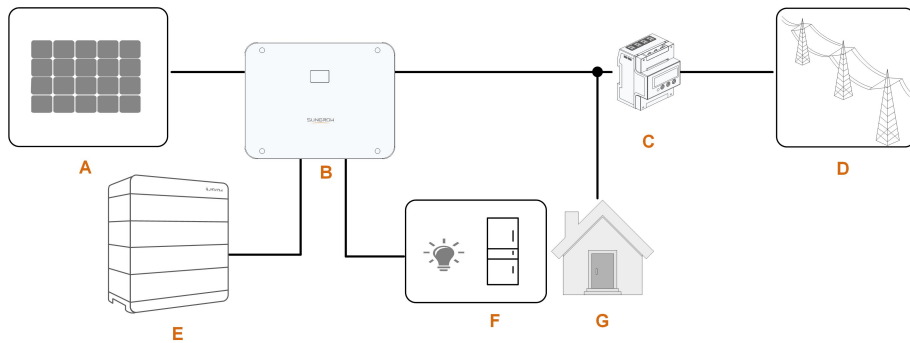

figure 2-4 PV Energy Storage System (PV ESS)

table 2-2 System Compositions

Item	Description	Remark
A	PV strings	Compatible with monocrystalline silicon, polycrystalline silicon, and thin-film without grounding.
B	Inverter	SH5-25T
C	Three-phase Smart Energy Meter	Measures the export power and communicates with the inverter via the RS485 port.
D	Utility grid	Grid grounding system types: TT, TN, TN-C-S, TN-S, TN-C, the type of grid grounding system depends on local regulations.
E	Battery (optional)	A Li-ion battery
F	Backup loads	Protected house loads directly connected to the inverter.
G	Normal Loads	Non protected house loads, they will disconnect in case of grid failure.

2.5.2 Declaration For Backup Function

⚠ DANGER

This product is not suitable for supplying power to life-sustaining medical devices since power outages may result in danger to life.

The following statement involves SUNGROW general policies about the hybrid inverters described in this document.

- 1 For hybrid inverters, the electrical installation typically includes connection of the inverter to both PV modules and batteries. If there is no available power from batteries or PV modules in backup mode, the backup power supply will be automatically terminated. SUNGROW shall hold no liability for any consequences arising from failing to observe this instruction.

- 2 When the inverter is working in backup mode, it supports up to 1.25kW single-phase half-wave loads.
- 3 Normally, the backup switching time is less than 10 ms. However, some external factors or local regulations may cause the system to fail on backup mode. Therefore, the users must be aware of conditions and follow the instructions as below:
 - Do not connect loads that are dependent on a stable energy supply for a reliable operation.
 - Do not connect the loads whose total capacity is greater than the maximum backup capacity.
 - Due to the condition of the battery itself, battery current might be limited by some factors, including but not limited to the temperature and weather.

Declaration For Backup Overload Protection

The inverter will restart in case of overload protection. The time required for restarting will increase if overload protection repeats. Try to reduce backup load power within maximum limitation or remove the loads which may cause very high start-up current surges.

2.5.3 Energy Management

The battery discharges to provide energy to loads. If the battery is empty or there is not enough power from the battery system, the grid shall supply power to backup loads and normal loads.

When the grid is present, the bypass function of the hybrid inverter is activated and the Backup loads will be directly connected to the grid via the bypass switch integrated in the inverter.

If the Smart Energy Meter is abnormal or not equipped, the inverter will run normally, however, the battery can be charged but not allowed to discharge. In this case the feed-in power setting will be ineffective, and the DO function for optimized mode will be disabled.

Energy Management during Daytime

The energy management system (EMS) works in self-consumption mode by default.

- Scenario 1: PV power generation \geq Load power consumption
 - First, PV power will go to Backup loads first, then normal loads and the battery.
 - Moreover, If the battery is fully charged, the excess will go to the grid. The feed-in power will not surpass the feed-in limitation value in initial settings.
- Scenario 2: PV power generation $<$ Load power consumption
 - First, battery will discharge and provide the energy missing.
 - Moreover, inverter will draw power from the mains if the power from the PV and battery is less than the load power.

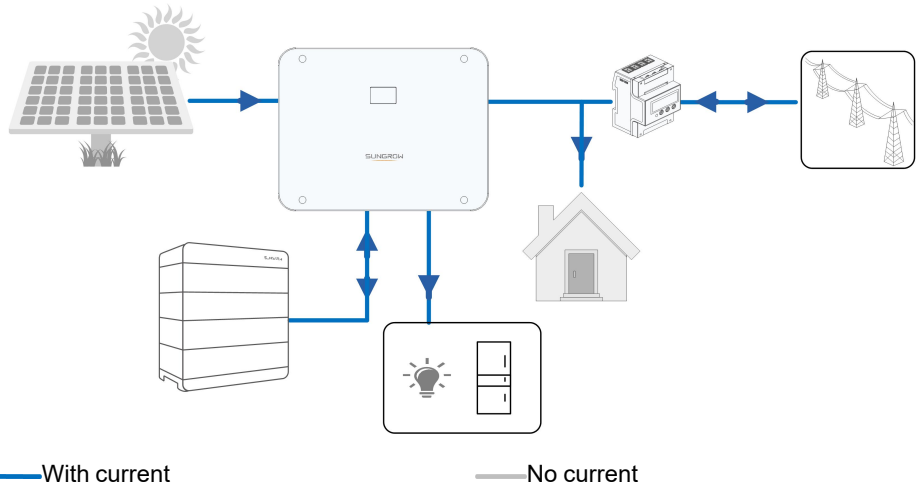

Energy Management during Night

During night, with energy available, the battery will discharge to supply power for loads. Alternatively, the grid will supply power for the loads in case the discharge power of the battery is insufficient.

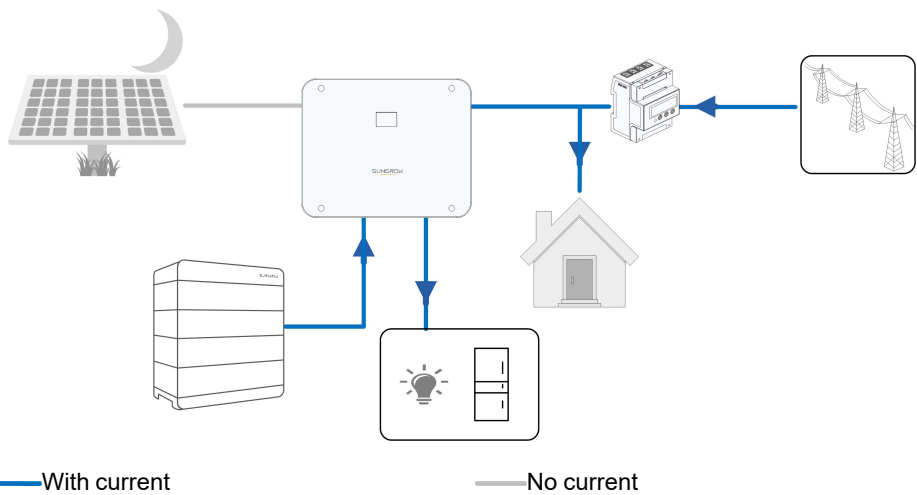

During night, when the battery is empty, it will enter into standby mode. In this case, the grid will supply all power for loads.

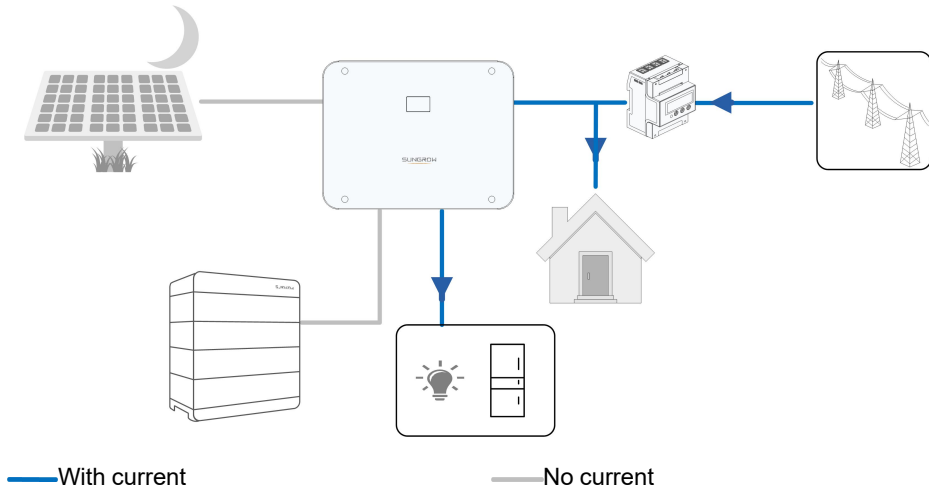

2.6 Parallel System

2.6.1 Grid-connected Parallel System

Maximum two hybrid inverters of the same type can be connected in parallel in the PV ESS via RS485 communication. Each hybrid inverter will independently provide power to loads attached at the LOAD terminal in case of a grid outage.

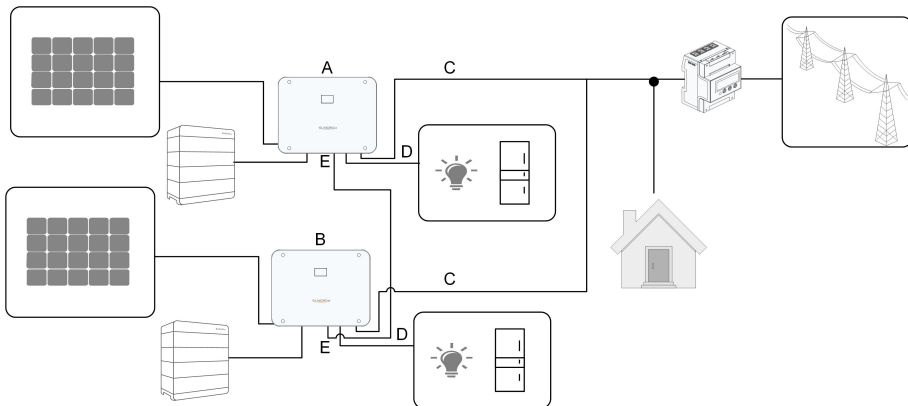

figure 2-5 Parallel PV ESS

- (A) Master
- (B) Slave 1
- (C) GRID
- (D) BACK-UP
- (E) RS485



Only the hybrid GRID terminals can be connected in parallel, the LOAD terminals and the battery terminals cannot be connected together. The backup loads of each inverter should not exceed its nominal power.

In an on-grid parallel system, the master inverter collects information from Smart Energy Meter and slave inverter and performs the energy management including:

- Feed-in power control
- Battery charge / discharge
- Maximum power limitation

The following settings are required for the inverter parallel function.

- Feed-in power control. The feed-in power control function refers to "[8.5.1 Feed-in Limitation](#)". The PV installation power of the master inverter is the total installation power of the system, the slave inverters do not need to set the feed-in power.
- Ripple Control. The Ripple Control device only needs to be connected to the master inverter, which will perform unified scheduling. Refer to "[6.8.2.4 DRM Connection](#)" for the cable connection. Refer to "[8.10.6 Active Power Regulation](#)" to enable it in the iSolarCloud App.
- Parallel Configuration. Refer to "[8.10.14 Parallel Configuration](#)" to configure the master and slave inverters on the iSolarCloud App.



For more information about the parallel connection of inverters, please contact SUNGROW.

2.7 Retrofitting the Existing PV System

The hybrid inverter is compatible with any three-phase PV grid-connected inverters. An existing PV system can be retrofitted to be a PV ESS with the addition of the hybrid inverter.

On-grid Port to Retrofit the Existing PV System

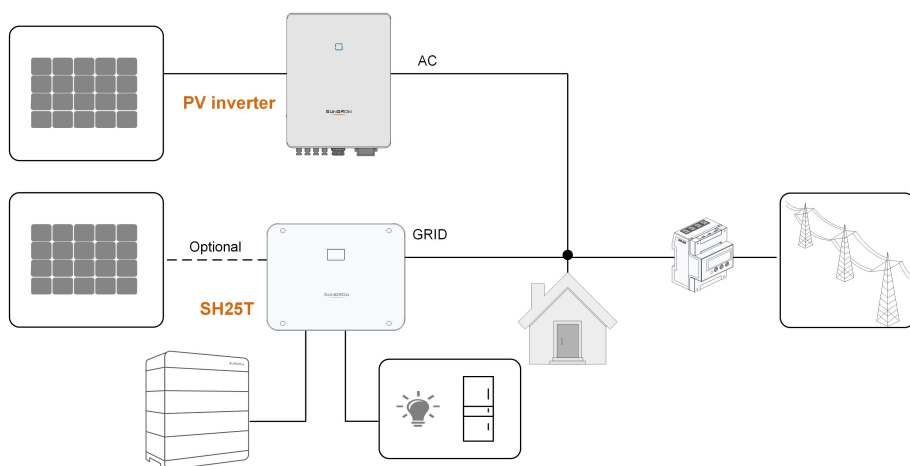

figure 2-6 On-grid Port to Retrofit the Existing PV System

The AC terminal of the PV inverter and the GRID terminal of the hybrid inverter are connected in parallel.

The power generation from the existing PV inverter will be firstly provided to the **loads** and then charge the **battery**. With the energy management function of the hybrid inverter, the self-consumption of the new system will be greatly improved.

Load Terminal to Retrofit the Existing PV System

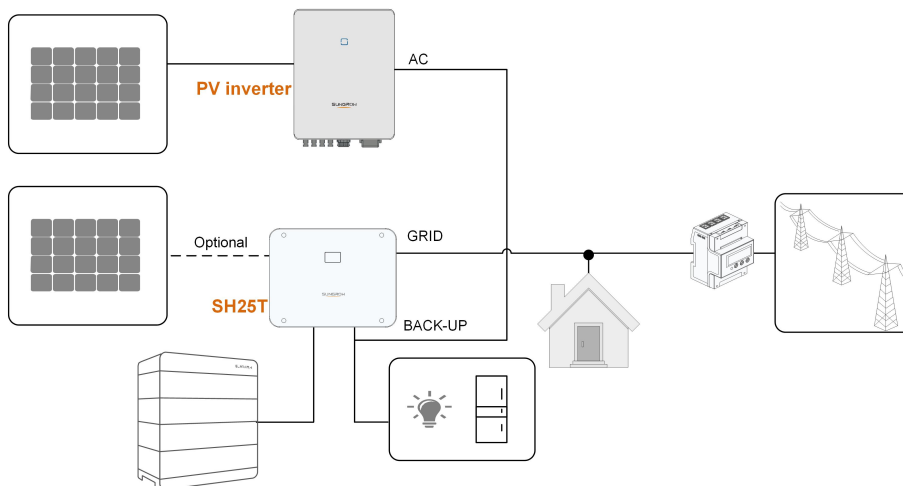

figure 2-7 Load Terminal to Retrofit the Existing PV System

The LOAD terminal retrofits the existing PV system in order to maximize the use of PV energy by allowing the PV inverter to work even when off-grid.

The AC terminal of the PV inverter and the LOAD terminal of the hybrid inverter are connected in parallel. This option is not available in the European region.

The PV inverter power cannot exceed the nominal power of the hybrid inverter (if it is a single-phase PV inverter, the PV inverter power cannot exceed the single-phase nominal power of the three-phase hybrid inverter).

Before retrofitting the existing PV system to an LOAD terminal, the "Frequency Shift Power Control" parameter needs to be enabled. For details, please refer to "[8.10.15 Frequency Shift Power Control](#)".

Note:

- 1 In zero-export scenario, the hybrid inverter can only ensure no power exported to grid itself but does not ensure zero export for the PV inverter. Please contact the PV inverter manufacturer for its zero-export solution.
- 2 PV modules for hybrid inverter are optional.

2.8 Whole Home Backup

In this scenario, all the household loads are connected to the LOAD terminal of the hybrid inverter. The energy supplied to the load does not come directly from the grid. If a grid failure happens, the household loads are still supplied with energy from PV or battery.

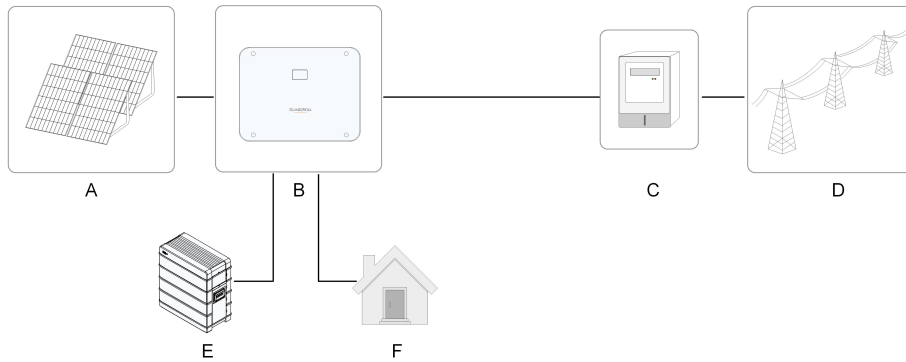

Item	Description	Note
A	PV strings	Compatible with monocrystalline silicon, polycrystalline silicon, and thin-film modules without grounding.
B	Inverter	SH5-25T
C	Metering device	Meter cupboard with power distribution system.
D	Utility grid	TT, TN-C, TN-S, TN-C-S.
E	Battery (optional)	A Li-ion battery.
F	Loads	Household loads, connected to inverter LOAD terminal.

Note: 1. In this scenario, the household load should be connected to the LOAD terminal.

2. The power of household loads connected should not exceed the maximum backup output of the inverter.

3. For the wiring diagram of the whole home backup scenario, see "[6.3 Electrical Connection Overview](#)".

3 Function Description

3.1 Safety Function

3.1.1 Protection

Several protective functions are integrated in the inverter, including short circuit protection, grounding insulation resistance surveillance, residual current protection, anti-islanding protection, DC overvoltage / over-current protection, etc.

3.1.2 Earth Fault Alarm

The inverter has integrated a multiple-function dry-contact (DO relay), which can be used for the external alarm for earth fault. The external alarm needs to be powered by the grid.

The additional equipment required is a light indicator and/or a buzzer.

If an earth fault occurs:

- the DO dry-contact will switch on automatically to signal the earth fault alarm;
- the buzzer inside the inverter will also beep;
- An earth fault alarm signal will be uploaded.

3.2 Energy Conversion and Management

The inverter converts the DC power from the PV array or the battery to the AC power, in conformity with the grid requirements. It also transmits the DC power from the PV panel to the battery.

With the bidirectional converter integrated inside, the inverter can charge or discharge the battery.

Multiple string MPP trackers are used to maximize the power from PV strings with different orientations, tilts, or module structures.

3.2.1 Power Derating

Power derating is a way to protect the inverter from overload or potential faults. In addition, the derating function can also be activated following the requirements of the utility grid. Situations requiring inverter power derating are:

3.2.2 DRM (“AU”/“NZ”)

The inverter provides a terminal block for connecting to a demand response enabling device (DRED). The DRED asserts demand response modes (DRMs). The inverter detects and initiates a response to all supported demand response commands within 2s.

The following table lists the DRMs supported by the inverter.

table 3-1 Demand Response Modes (DRMs)

Mode	Explanation
DRM0	The inverter is in the state of "Turn off".
DRM1	The import power from the grid is 0.
DRM2	The import power from the grid is no more than 50 % of the rated power.
DRM3	The import power from the grid is no more than 75 % of the rated power.
DRM4	The import power from the grid is 100 % of the rated power, but subject to the constraints from other active DRMs.
DRM5	The feed-in power to the grid is 0.
DRM6	The feed-in power to the grid is no more than 50 % of the rated power.
DRM7	The feed-in power to the grid is no more than 75 % of the rated power.
DRM8	The feed-in power to the grid is 100 % of the rated power, but subject to the constraints from other active DRMs.

The DRED may assert more than one DRM at a time. The following shows the priority order in response to multiple DRMs.

Multiple Modes	Priority Order
DRM1...DRM4	DRM1 > DRM2 > DRM3 > DRM4
DRM5...DRM8	DRM5 > DRM6 > DRM7 > DRM8



The SH5-25T only supports DRM0.

3.2.3 Regular Operational Voltage Range

The inverters can operate within the allowable voltage range for at least the specified observation time. The setting of the conditions depends on whether the connection is due to a normal operational start-up or an automatic reconnection after disconnection from grid.

When the voltage level is out of the operational and protection levels, the inverter will disconnect within the specified time from the grid. If a disturbance lasts longer than the required protection time, the inverter can reconnect to the grid once the voltage level goes back to normal levels after the disturbance.

3.2.4 Regular Operational Frequency Range

The inverter can operate within its frequency range for at least the specified observation time. The setting of conditions depends on whether the connection is due to a normal operational start-up or an automatic reconnection after disconnection from grid.

When the frequency level is outside the operational and protection levels, the inverter will disconnect from the grid. If a disturbance lasts longer than the required protection time, the inverter can reconnect to the grid once the frequency level goes back to normal levels after the disturbance.

3.2.5 Reactive Power Regulation

The inverter is capable of operating in reactive power regulation modes for the purpose of providing support to the grid. The reactive power regulation mode can be set via the iSolar-Cloud App.

3.2.6 Load Control

The inverter has an integrated multiple-function dry-contact (DO relay), which can be used for load control via a contactor.

User may set the control mode according to individual demand.

3.3 Battery Management

Li-ion battery from SUNGROW are compatible with the PV ESS , further battery models will be made compatible in the future.

The currently supported battery brands and models are shown in the following table.

Brand	Model	Firmware Version
SUN-GROW	SBR096/128/160/192/224/256	≥ SBRBCU-S_22011.01.19
	SUNGROW (SBH100/150/200/250/300/350/400)	≥ SBHBCU-S_22011.04.02



The table is continually updated. If the battery model is not in the table, consult SUNGROW if it is supported.

To maximize the battery life, the inverter will perform battery charge, discharge, and battery maintenance based on the battery status communicated by the BMS.

NOTICE

- **The recommended parameters listed in this section may be updated or revised due to product development. Please refer to the manual supplied by the battery manufacturer for the latest information.**
- **If a third-party battery product is to be used, please consult the manufacturer for the battery's charge and discharge performance. SUNGROW cannot guarantee that the use of a third-party battery product would allow the optimal performance of the hybrid inverter.**

State Definition

In order to avoid overcharging or deep discharging of the battery, three battery statuses according to different voltage ranges has been defined, as shown in the following table.

table 3-2 Battery Status Definition

Type	Port Voltage / SOC		
	Empty	Normal	Full
SUNGROW (SBR096/128/160/ 192/224/256)	SOC < 5 %	5 %...100 % (by default)	SOC = 100 %
SUNGROW (SBH100/150/200/ 250/300/350/400)			

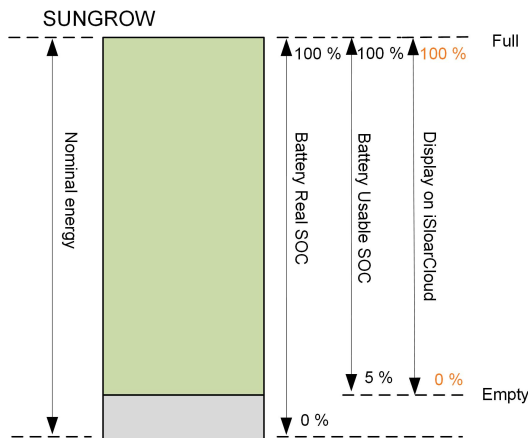

The SOC limits of Li-ion batteries can be modified via the iSolarCloud App by qualified personnel.

NOTICE

If the battery has not been used or fully charged for a long time, it is recommended to charge the battery manually every 15 days to at least 15% to ensure battery life and performance.

3.3.1 Charge Management

Backup Charge Management

The emergency charge management function is to protect the battery from the damage caused by long time excessive discharge. The inverter cannot respond to discharge command during emergency charge. The following tables describe the emergency charge conditions for different types of batteries.

table 3-3 Backup Charge Management for Li-ion Battery

Status	Conditions
Trigger	Either of the following conditions is met:
	<ul style="list-style-type: none"> • $SOC \leq (\text{Min. SOC}) - 3\%$ (valid only when the Min. SOC is $\geq 3\%$). • A battery under-voltage warning is triggered. • An emergency charge command is reported to the inverter.
	All the following conditions are met:
Finish	<ul style="list-style-type: none"> • $SOC \geq (\text{Min. SOC}) - 1\%$ (valid only when the Min. SOC is $\geq 3\%$). • The battery under-voltage warning is cleared. • The emergency charge command reported to the inverter is cleared.

table 3-4 Default SOC Conditions for Li-ion Battery Backup Charge

Type	Trigger SOC	Finishing SOC
SUNGROW	$SOC \leq 2\%$	$SOC \geq 4\%$

Normal Charge Management

When the battery voltage is within the normal range, the inverter can charge the battery if the PV power is higher than the load power and can ensure that the battery is never over-charged.

The maximum allowable charge current is limited to the smaller value among the following:

- the maximum charge current of the inverter (50A);
- the maximum / recommended charge current from the battery manufacturer.

For this reason, the battery charge power may not reach the nominal power.



- If the PV voltage is higher than 950 V, the battery cannot charge.
- The hybrid inverter will start to charge the battery when the export power value exceeds a pre-defined threshold value of 70 W.

3.3.2 Discharge Management

Discharge management can effectively protect the battery from deep discharging.

The maximum allowable discharge current is limited to the smaller value among the following:

- the maximum discharge current of the inverter ;
- the maximum / recommended discharge current from the battery manufacturer.

For this reason, the battery discharge power may not reach the nominal power.



- If the PV voltage is higher than 950 V, the battery cannot discharge.

3.4 Communication and Configuration

The inverter possesses various ports for device and system monitoring, including RS485, Ethernet, WLAN, and CAN; various parameters can be configured for optimal operation. The inverter information is accessible through the iSolarCloud App.

4 Unpacking and Storage

4.1 Unpacking and Inspection

The product is thoroughly tested and strictly inspected before delivery. Nonetheless, damage may still occur during shipping. For this reason, please conduct a thorough inspection after receiving the product.

- Check the packing case for any visible damage.
- Check the scope of delivery for completeness according to the packing list.
- Check the inner contents for damage after unpacking.

Contact SUNGROW or the transport company in case of any damage or incompleteness, and provide photos to facilitate services.

Do not dispose of the original packing case. It is recommended to store the device in the original packing case when the product is decommissioned.

NOTICE

- **After receiving the product, check whether the appearance and structural parts of the device are damaged, and check whether the packing list is consistent with the actual ordered product. If there are problems with the above inspection items, do not install the device and contact your distributor first. If the problem persists, contact SUNGROW in time.**
- **If any tool is used for unpacking, be careful not to damage the product.**

4.2 Scope of Delivery

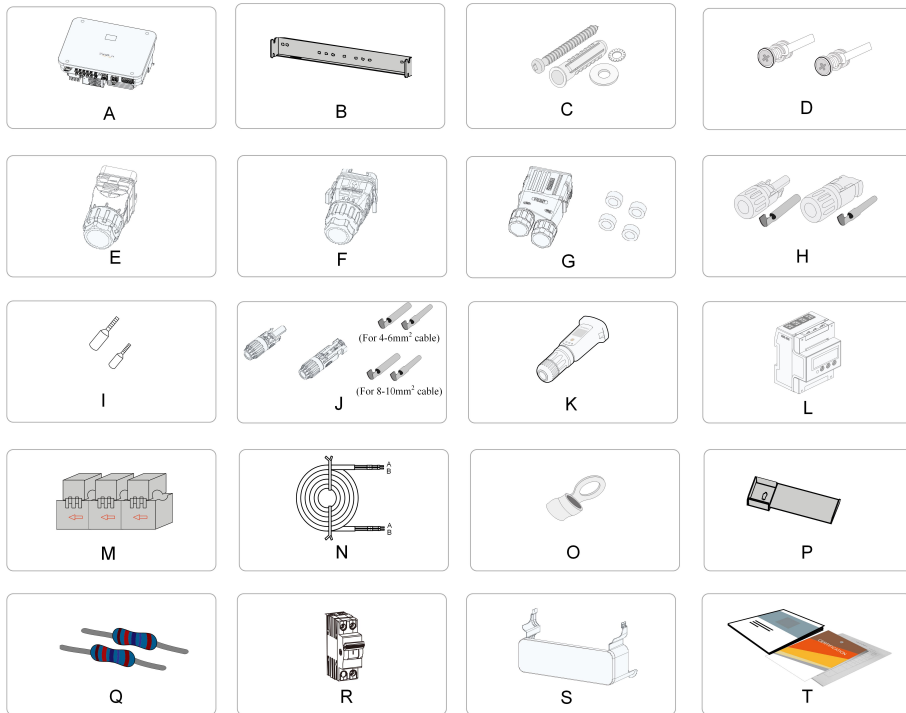

figure 4-1 Scope of delivery

Item	Name	Quantity
A	Inverter	1
B	Wall-mounting bracket	1
C	Expansion plug set	4
D	M5×12 screws and washers	2
E	COM2 connector set	1
F	COM1 connector set	1
G	AC connector set	1
H	PV connectors	5
I	Cord end terminal*	10-33
J	Battery connectors*	1
K	WiNet-S2 module	1
L	Smart Energy Meter	1
M	Current Transformer(CT)	1
N	RS485 cable	1
O	OT terminal	1
P	Bottom bracket	1
Q	120Ω resistor	2
R	Manual Changeover Switch(63A)**	1
S	Protective Cover**	1
T	Documents	1

* The images shown here are for reference. The actual product and quantity are based on delivery.

** These accessories are included in the scope of delivery only in Australia currently.

4.3 Inverter Storage

Proper storage is required if the inverter is not installed immediately.

- Store the inverter in the original packing case with the desiccant inside.
- In case of stacking storage, the number of stacking layers should never exceed the limit marked on the outer side of the packing case.
- The packing case should be upright.
- If the inverter needs to be transported again, pack it strictly before loading and transporting it.
- Do not store the inverter in places susceptible to direct sunlight, rain, and strong electric field.
- Do not place the inverter in places with items that may affect or damage the inverter.
- Store the inverter in a clean and dry place to prevent dust and water vapor from eroding.
- Do not store the inverter in places with corrosive substances or susceptible to rodents and insects.
- Carry out periodic inspections. Inspection shall be conducted at least once every six months. If any insect or rodent bites are found, replace the packaging materials in time.
- If the inverter has been stored for more than a year, inspection and testing by professionals are required before it can be put into operation.

NOTICE

Please store the inverter according to the storage requirements. Product damage caused by failure to meet the storage requirements is not covered by the warranty.

5 Mechanical Mounting

WARNING

Respect all local standards and requirements during mechanical installation.

5.1 Safety During Mounting

DANGER

Make sure there is no electrical connection before installation.
Before drilling, avoid the water and electricity wiring in the wall.

WARNING

For specific requirements for the installation environment, see "[5.2.1 Installation Environment Requirements](#)". In case the environment where the device is installed does not meet the requirements, SUNGROW shall not be held liable for any property damage arising therefrom.

CAUTION

Improper handling may cause personal injury!

- When moving the inverter, be aware of its weight and keep the balance to prevent it from tilting or falling.
- Wear proper protective equipment before performing operations on the inverter.
- The bottom terminals and interfaces of the inverter cannot directly contact the ground or other supports. The inverter cannot be directly placed on the ground.

NOTICE

When installing devices, ensure that no device in the system causes it hard for the DC switch and the AC circuit breaker to act or hinders maintenance personnel from operating.

If drilling is required during installation:

- Wear goggles and protective gloves when drilling holes.
- Make sure to avoid the water and electricity wiring in the wall before drilling.
- Protect the product from shavings and dust.

5.2 Location Requirements

To a large extent, a proper installation location ensures safe operation, service life, and performance of the inverter.

- The inverter with protection rating IP65 can be installed both indoors and outdoors.
- The inverter should be installed at a height that allows easy viewing of the LED indicator panel, as well as easy electrical connection, operation and maintenance.

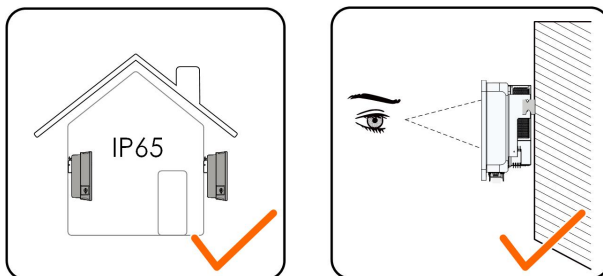

5.2.1 Installation Environment Requirements

- If the inverter is installed in a place with lush vegetation, weed on a regular basis. In addition, the ground beneath the inverter needs to undergo certain treatment, such as laying cement or gravel, etc. (an area of 3m×2.5m is recommended).
- Do not install the inverter in an environment with flammables, explosives, or smoke.
- Do not install the inverter in places prone to water leak, e.g., under the air-conditioner vent, the air vent, or the cable outlet window of the machine room, so as to prevent device damage or short circuit caused by intrusion of water.
- Do not install the inverter in a place with corrosives such as corrosive gas and organic solvent, etc.
- When the inverter is running, its surface may carry high voltages or get very hot. Do not touch it; otherwise, it may lead to burns or electric shocks.
- Do not install the inverter in a place that is easy to reach for people.
- Good heat dissipation is very important to the inverter. Please install the inverter in a ventilated environment.
- Please consult SUNGROW before installing inverters outdoors in areas prone to salt damage, which mainly are coastal areas within 500 meters of the coast. The sedimentation amount of salt spray is correlated to the characteristics of the seawater, sea winds, precipitation, air humidity, topography, and forest coverage in the adjacent sea areas, and there are substantial differences between different coastal areas.
- Do not install the inverter in an environment contaminated with chemicals such as halogen and sulfide.
- Do not install the inverter in an environment with vibration and strong electromagnetic field. Strong-magnetic-field environments refer to places where magnetic field strength measures over 30 A/m.

- In dusty environments such as places full of dust, smoke, or floc, particles may cling to the device's air outlet or heat sink, thus impacting its heat dissipation performance or even getting it damaged. Therefore, do not install the inverter in dusty environments. If the inverter has to be installed in such environments, please clean its fans and heat sink on a regular basis to ensure a good heat dissipation performance.
- The average temperature approximately 1 m around the inverter should be taken as its operating temperature. The temperature and humidity should meet the requirements below:

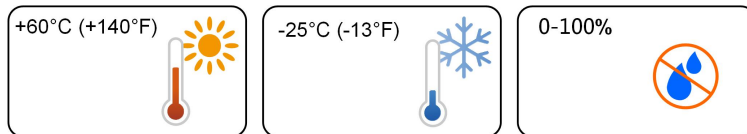

5.2.2 Carrier Requirements

The mounting structure where the inverter is installed must comply with local/national standards and guidelines. Ensure that the installation surface is solid enough to bear four times the weight of the inverter and is suitable for the dimensions of the inverter (e.g. cement walls, plasterboard walls, etc.).

Do not install the inverter on a carrier that may vibrate in resonance, so as to avoid making bigger noise.

The structure should meet the following requirements:



5.2.3 Angle Requirements

Install the inverter vertically. Never install the inverter horizontally, or at forward/backward tilted, side tilted, or upside down.

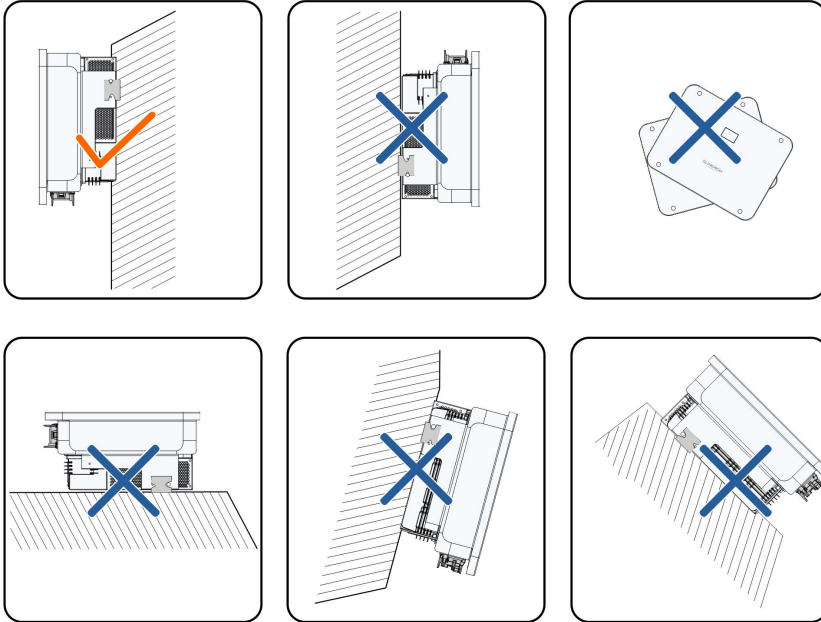

5.2.4 Clearance Requirements

Reserve enough clearance around the inverter to ensure sufficient space for heat dissipation.

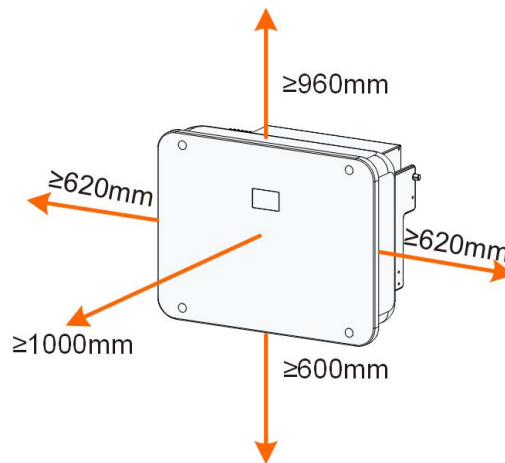

In case of multiple inverters, reserve specific clearance between the inverters.

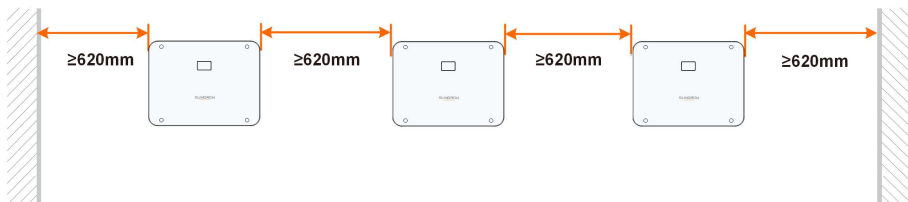

5.3 Installation Tools

Installation tools include but are not limited to the following recommended ones. If necessary, use other auxiliary tools on site.

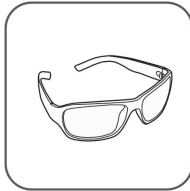

Goggles

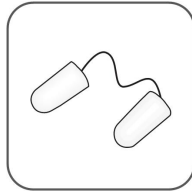

Earplugs

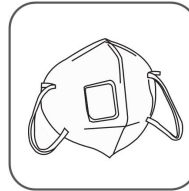

Dust mask



Safety gloves



Safety shoes

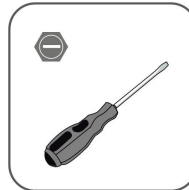
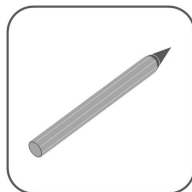

Utility knife

Slotted screwdriver
(M4、M2)Phillips screwdriver
(M5)Hammer drill
($\phi 10$)

Marker



Vacuum cleaner

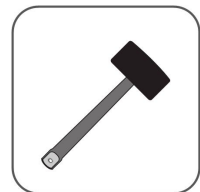

Rubber mallet

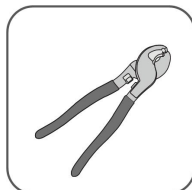
Anti-static wrist
strap

Wire cutter

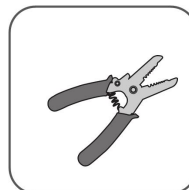

Wire stripper

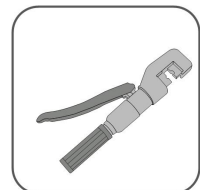

Hydraulic pliers

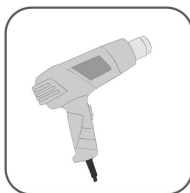

Heat gun

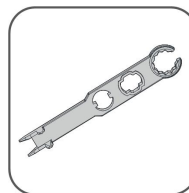
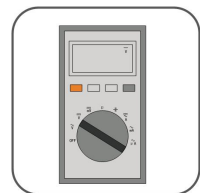
Crimping tool
4–6mm²
10mm²Wrench for Battery
terminalMultimeter
≥ 1000V DC

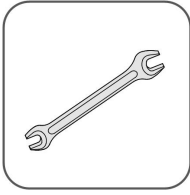

Open-end wrench
(24 mm, 35 mm)

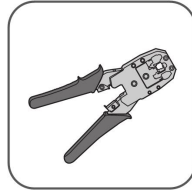

RJ45 crimping tool

5.4 Moving the Inverter

Before installation, remove the inverter from the packing case and move it to the installation site. Follow the instructions below as you move the inverter:

- Always be aware of the weight of the inverter.
- Lift the inverter using the handles positioned on both sides of the inverter.
- Move the inverter by one or two people or by using a proper transport tool.
- Do not release the equipment unless it has been firmly secured.

⚠ CAUTION

Improper handling may cause personal injury!

- **Arrange an appropriate number of personnel to carry the inverter according to its weight, and installation personnel should wear protective equipment such as anti-impact shoes and gloves.**
- **Attention must be paid to the center of gravity of the inverter to avoid tilting during handling.**
- **Placing the inverter directly on a hard ground may cause damage to its metal enclosure. Protective materials such as sponge pad or foam cushion should be placed underneath the inverter.**
- **Move the inverter by holding the handles on it. Do not move the inverter by holding the terminals.**

5.5 Installing the Inverter

Install the inverter on the wall using the provided wall-mounting bracket and expansion plug sets.

The expansion plug set shown below is recommended for the installation.

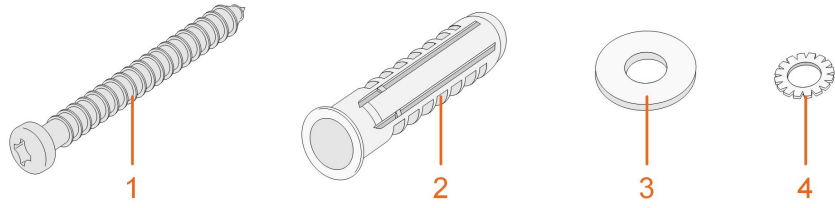

(1) Self-tapping screw (2) Expansion tube (3) Fender washer (4) Spring washer

step 1 Place the wall-mounting bracket to a proper position on the wall. Mark the positions and drill the holes.

NOTICE

Observe the level on the bracket and adjust until the bubble is in the middle position.

The depth of the holes should be about 70 mm.

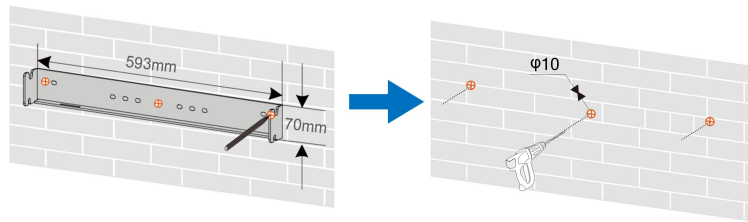

* The image shown here is for reference only. The actual product received may differ.

step 2 Place the expansion tubes into the holes. Then secure the wall-mounting bracket to the wall firmly with the expansion bolt sets.

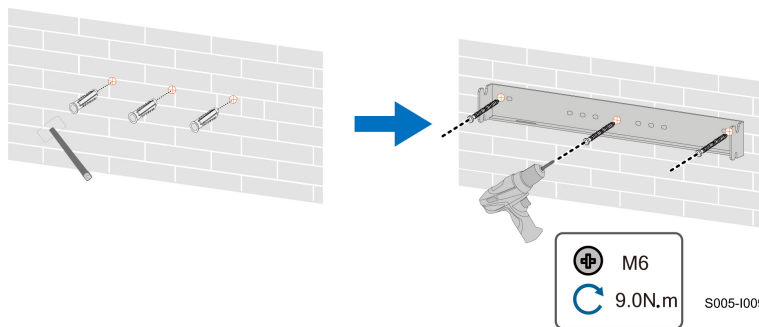

step 3 Install the bottom bracket to avoid the inverter tilting forward.

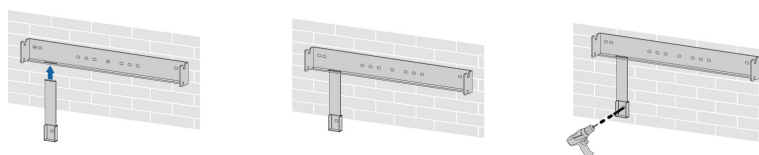

step 4 Lift the inverter and slide it down along the wall-mounting bracket to make sure they match perfectly. Use two screw sets to lock both left and right sides.

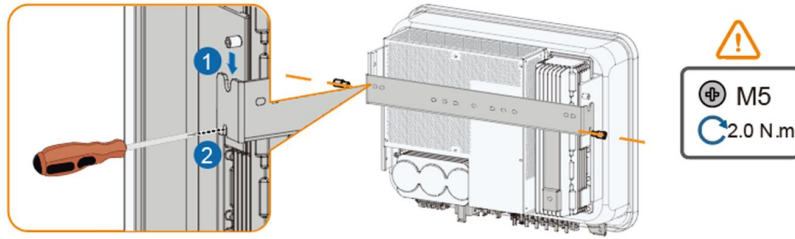

-- End

6 Electrical Connection

6.1 Safety Instructions

DANGER

The PV string will generate lethal high voltage when exposed to sunlight.

- Operators must wear proper personal protective equipment during electrical connections.
- Must ensure that cables are voltage-free with a measuring instrument before touching DC cables.
- Respect all safety instructions listed in relevant documents about PV strings.

DANGER

- Before electrical connections, please make sure that the inverter switch and all switches connected to the inverter are set to "OFF", otherwise electric shock may occur!
- Ensure that the inverter is undamaged and all cables are voltage free before performing electrical work.
- Do not close the AC circuit breaker until the electrical connection is complete.

DANGER

Batteries deliver electric power, resulting in burns or a fire hazard when they are short circuited, or wrongly installed.

Lethal voltages are present at the battery terminals and cables connecting to the inverter. Severe injuries or death may occur if the cables and terminals in the inverter are touched.

WARNING

Damage to the product caused by incorrect wiring is not covered by the warranty.

- Electrical connection must be performed by professionals.
- Operators must wear proper personal protective equipment during electrical connections.
- All cables used in the PV generation system must be firmly attached, properly insulated, and adequately dimensioned.

NOTICE

All electrical connections must comply with local and national / regional electrical standards.

- **Cables used by the user shall comply with the requirements of local laws and regulations.**
- **Only with the permission of the national / regional grid department, the inverter can be connected to the grid.**

NOTICE

- **Before connecting a power cable (such as the AC cable, the DC cable, etc.), confirm that the label and identifier on the power cable are correct.**
- **Please make sure to divide the AC output cable from the DC input cable during the electrical connection to avoid any possible short circuit.**
- **When laying out communication cables, separate them from power cables and keep them away from strong interference sources to prevent communication interruption.**

NOTICE

All vacant terminals must be covered with waterproof covers to prevent affecting the protection rating.

When the wiring is completed, seal the gap of cable inlet and outlet holes with fire-proof / waterproof materials such as fireproof mud to prevent foreign matter or moisture from entering and affecting the long-term normal operation of the inverter. Comply with the safety instructions related to PV strings and the regulations related to the utility grid.



- If excessive loads are connected to the inverter backup port, the inverter will shut down for protection. Please remove some loads and restart the inverter.
- The cable colors in figures in this manual are for reference only. Please select cables according to local cable standards.

6.2 Terminal Description

All electrical terminals are located at the bottom of the inverter.

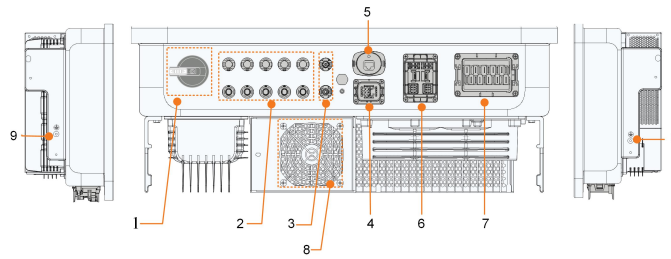

figure 6-1 Terminals at the Bottom of the Inverter

* The image shown here is for reference only. The actual product received may differ.

No.	Name	Description
1	DC switch	Used to disconnect PV - only when there is no PV production
2	PV terminals	Positive and negative DC input connectors The terminal number depends on inverter model
3	Battery connection	Connectors for the battery power cables
4	COM1 terminal	Communication port for parallel connection of inverters
5	WLAN terminal	Connector for the WiNet—S2 module
6	COM2 terminal	Communication connection for Smart Energy Meter, EV Charger, BAT, Logger, DRM, RSD and DO
7	LOAD terminal and GRID terminal	AC terminal reserved for loads (household loads and backup loads) and grid
8	Fan	Used for inverter heat dissipation. The number of fans varies by product model: Not available for SH5-20T, 1 for SH25T
9	Additional grounding terminal	Used for reliable grounding

COM1 Terminal

COM1 is a communication port mainly used for the parallel connection of inverters. Details about this terminal are shown below:

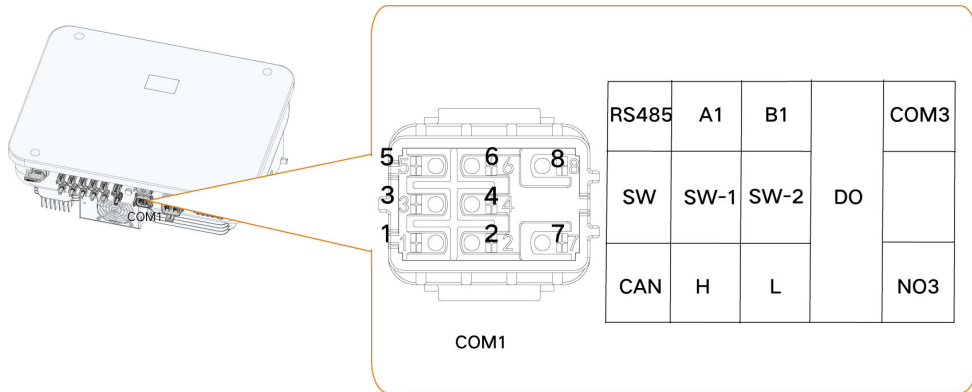

table 6-1 The Label Description of COM1 Terminal

Label	Description
RS485 (A1, B1)	RS485 communication port for parallel connection of inverters
SW (SW-1, SW-2)	Reserved
CAN (H, L)	CAN communication port for parallel connection of inverters
DO (COM3, NO3)	Intelligent control switch for parallel connection of inverters (connect the host only)

COM2 Terminal

COM2 is used mainly for establishing communication with devices such as meter, EV charger, and battery. Details about this terminal are shown below:

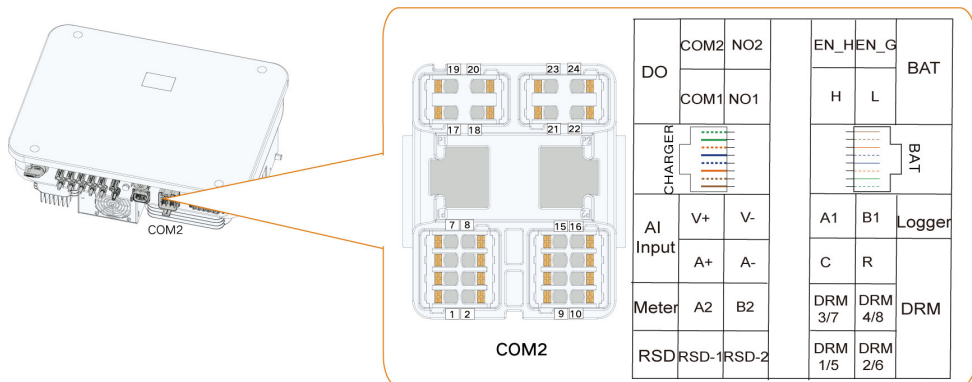
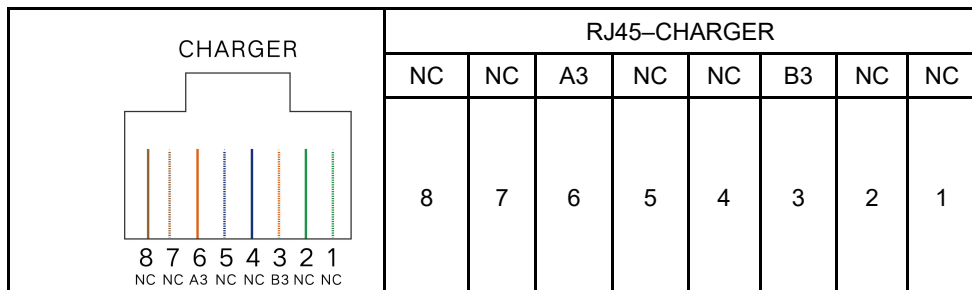

table 6-2 The label of RJ45 terminal



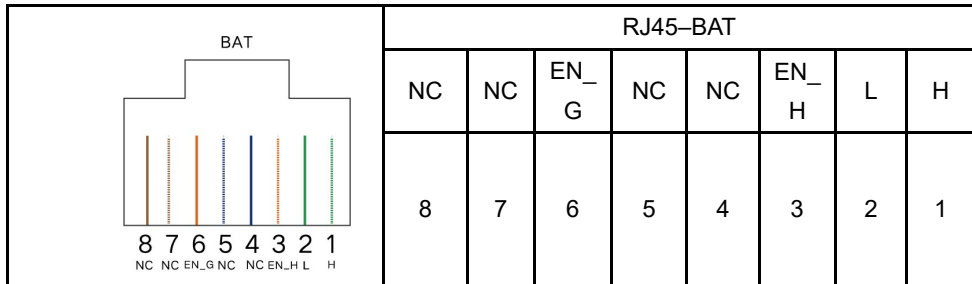

table 6-3 The label description of COM2 terminal

Label	Description
DO	<ul style="list-style-type: none"> DO (COM1, NO1): Grounding fault/alarm DO (COM2, NO2): Diesel generator start/stop
AI Input	Reserved
Meter (A2, B2)	Connect to the Smart Energy Meter (If installing a single inverter or if installing the master inverter in a string of parallel inverters.)
RSD (RSD-1, RSD-2)	Reserved
BAT	BAT (EN_H, EN_G): Enable the battery with a voltage of 12V. BAT (H, L): To enable the communication between the inverter and the Li-ion battery
Logger (A1, B1)*	Connect to the Logger in the parallel connection, so as to implement data exchange with PC or other monitoring devices.
DRM	<ul style="list-style-type: none"> "AU"/"NZ": Demand response enabling device (DRED) "IT": Interface protection system (SPI) "DE": Ripple Control Receiver (RCR)
RJ45-CHARGER (A3, B3)	RJ45 port for communication between the inverter and the EV charger
RJ45-BAT (EN_H, EN_G)	RJ45 port for communication between the inverter and the battery

*The length of the RS485 communication cable cannot exceed 1200m (1200m is supported for the default baud rate of 9600 only).

6.3 Electrical Connection Overview

System Wiring Diagram

The system wiring diagram is shown below:

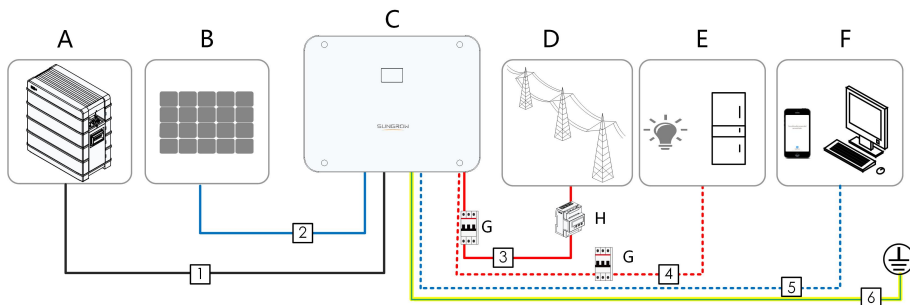

- (A) Battery (B) PV string (C) Inverter
 (D) Grid (E) Backup loads (F) Monitoring device
 (G) AC circuit breaker (H) Smart Energy Meter

NOTICE

Make sure not to switch the phase order (L1-L3), which may cause malfunction.

table 6-4 Cable requirements





N- o.	Cable	Type	Specification	
			Outer diame- ter(mm)	Cross section (mm ²)
1	Battery Power Cable	Outdoor multi-core copper wire cable, complying with 1,000V standard	6.4~8.5	SBR064-256: 6 (10AWG) SBH100-400: 10 (7AWG)
2	DC cable	PV cable, complying with 1,000V standard	6.4~8.0	4~6 (12 ~ 10AWG)
3, 4	AC cable *	Outdoor multi-core copper wire cable	SH5-12T: 14.4~23 SH15-25T: 21~27.5	SH5-12T: 6~10 (10 ~ 7AWG) SH15-25T: 10~16 (7 ~ 5AWG)
5	Communica- tion cable	Shielded twisted-pair cable CAT 5E outdoor shielded network cable	5~6.4	2 * (0.5 ~ 0.75) (20 ~ 18AWG) 8 * 0.2 (24AWG)
6	Additional Grounding cable	Outdoor single-core cop- per wire cable	The same as that of the PE wire in the AC cable	

*In the whole home backup scenario (where household loads are all connected to the LOAD terminal), the AC cable should be selected according to the actual household loads:

1. If $27.6\text{kVA (40A)} \leq \text{household loads} \leq 43\text{kVA (63A)}$, use a cable with a wire cross-sectional area of 16 mm^2 ;
 2. If $13.8\text{kVA (20A)} \leq \text{household loads} \leq 27.6\text{kVA (40A)}$, use a cable with a wire cross-sectional area of $10\sim 16\text{ mm}^2$;
 3. If household loads $\leq 13.8\text{kVA (20A)}$, use a cable with a wire cross-sectional area of $6\sim 10\text{ mm}^2$.
- If local regulations have other requirements for AC cables and additional grounding cable, select cable specifications according to the local regulations.
 - The factors that affect cable selection include rated current, cable type, routing mode, ambient temperature, and maximum expected line loss.
 - The cabling distance between the battery and the inverter should be less than 10 m, and within 5 m is recommended.

Wire Sizes for Different Terminals

table 6-5 Wire sizes for different terminals

Terminal					
Wire cross-sectional area (mm ²)	0.5mm ²	0.75mm ²	10mm ²	16mm ²	16mm ²
Cable	Communication cable	Communication cable	AC cable	AC cable	AC cable

Backup Wiring Diagram (Australia and New Zealand)

The neutral cable of GRID side and BACK-UP side must be connected together according to the wiring rules AS/NZS_3000. Otherwise the backup function will not work.

Loads Connected to the Grid:

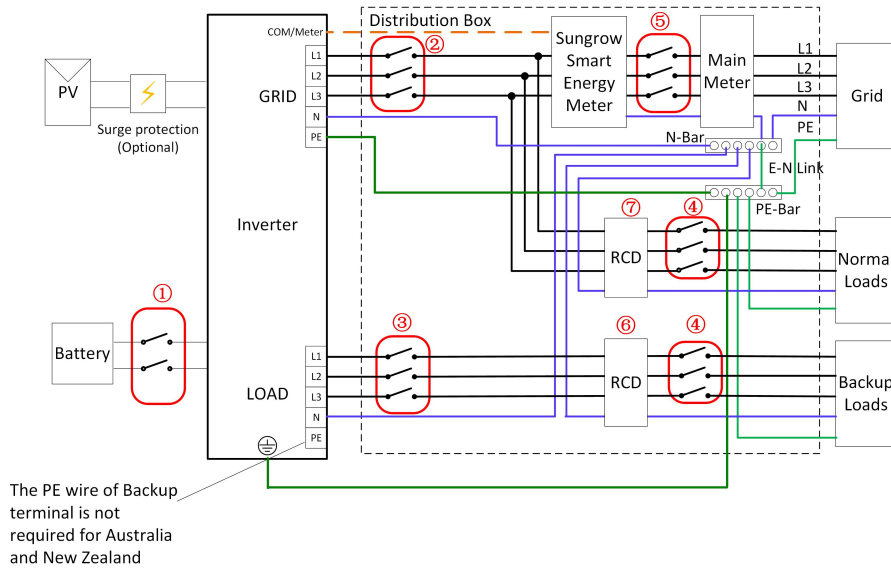

NO.	SH5/6T	SH8/10/12T	SH15T	SH20/25T
①	63A/800V DC breaker *			
②	≥25A/400V TypeB AC breaker	≥32A/400V TypeB AC breaker	≥40A/400V TypeB AC breaker	≥63A/400V TypeB AC breaker
③	Depends on loads			
④	Depends on loads			
⑤	Depends on household loads and inverter capacity			
⑥⑦	30mA RCD (Comply with local regulation)			

- *If the battery is integrated with a readily accessible internal DC breaker, no additional DC breaker is required.
- The values in the table are recommended values and can be set to other values according to actual conditions.
- To improve the safety of the system, set the “Import Power Limit” for the inverter immediately after completing the wiring. The formula used to calculate the import power limit should be: Set value of Import Power Limit (kW) ≤ 3*230*0.8*rated current of the house's main switch. For instructions on parameter setting, see "8.10.16 Import Power Limit".

Whole Home Backup Wiring Diagram (Australia and New Zealand)

Whole Home Backup:

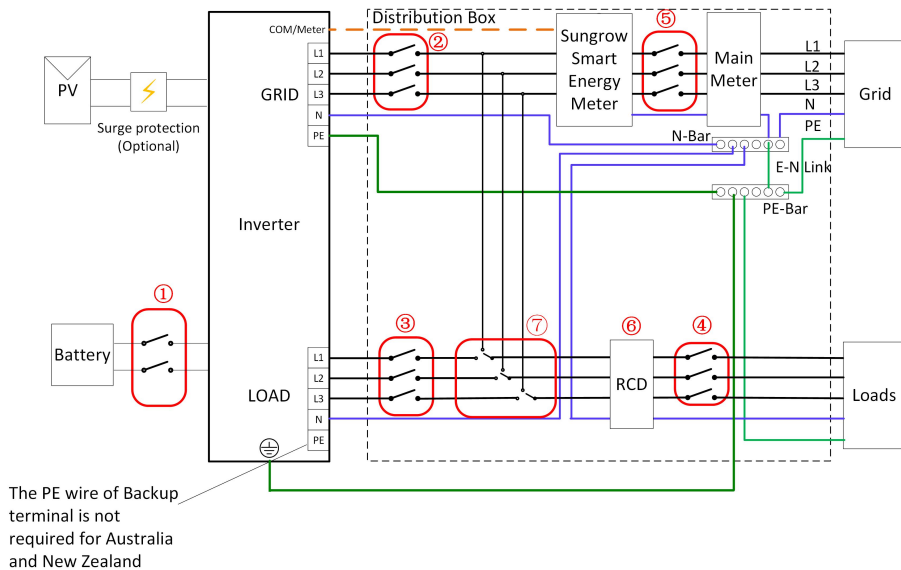

NO.	SH5/6T	SH8/10/12T	SH15T	SH20/25T
①	63A/800V DC breaker			
②	≥63A/400V TypeB AC breaker			
③	Depends on loads			
④	Depends on loads			
⑤	Depends on household loads and inverter capacity			
⑥	30mA RCD (Comply with local regulation)			
⑦	63A/230V manual changeover switch*			

*The manual changeover switch is included in the scope of delivery. A 63A manual changeover switch is required for the whole home backup scenario. When switching to "LOAD" using the changeover switch, household loads will be supplied by the PV installation and battery. When the inverter is faulty or undergoing maintenance, switch to "GRID" to ensure the loads can work normally.

Backup Wiring Diagram (Other Countries)

The following diagram is an example for grid systems without special requirement on wiring connection.

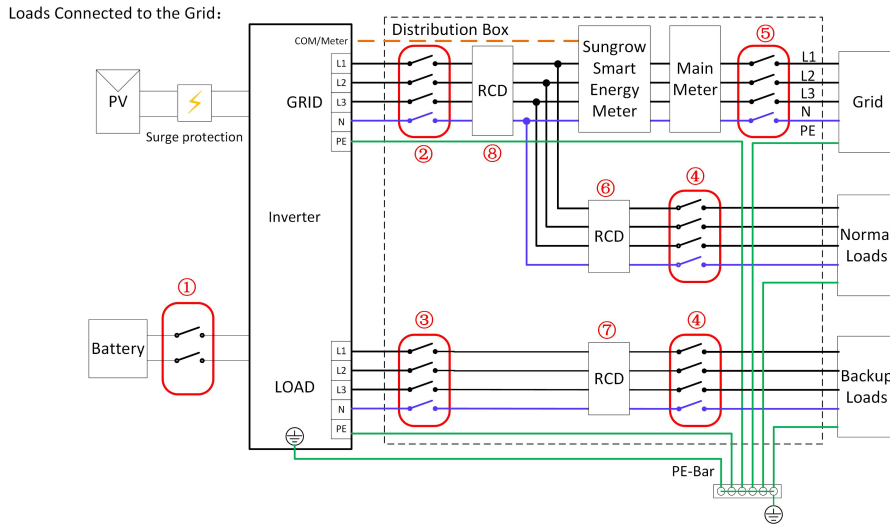

NO.	SH5/6T	SH8/10/12T	SH15T	SH20/25T
①	63A/800V DC breaker *			
②	≥25A/400V TypeB AC breaker	≥32A/400V TypeB AC breaker	≥40A/400V TypeB AC breaker	≥63A/400V TypeB AC breaker
③	Depends on loads			
④	Depends on loads			
⑤	Depends on household loads and inverter capacity			
⑥⑦	30mA RCD (Comply with local regulation)			
⑧	300mA RCD (Comply with local regulation)			

- *If the battery is integrated with a readily accessible internal DC breaker, no additional DC breaker is required.
- The values in the table are recommended values and can be set to other values according to actual conditions.
- To improve the safety of the system, set the “Import Power Limit” for the inverter immediately after completing the wiring. The formula used to calculate the import power limit should be: Set value of Import Power Limit (kW) ≤ 3*230*0.8*rated current of the house's main switch. For instructions on parameter setting, see "8.10.16 Import Power Limit".

Whole Home Backup Wiring Diagram (Other Countries)

Whole Home Backup:

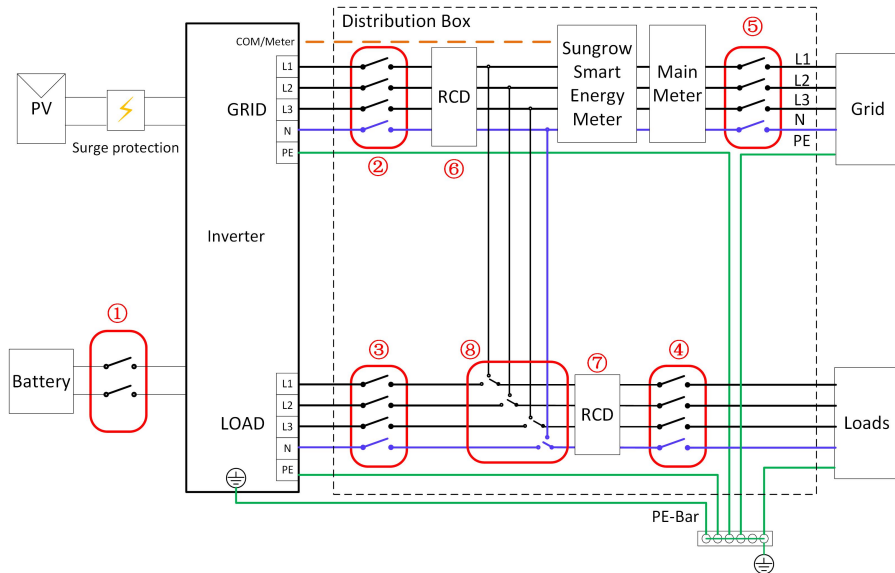

NO.	SH5/6T	SH8/10/12T	SH15T	SH20/25T
①		63A/800V DC breaker		
②		≥63A/400V TypeB AC breaker		
③		Depends on loads		
④		Depends on loads		
⑤		Depends on household loads and inverter capacity		
⑥		300mA RCD (Comply with local regulation)		
⑦		30mA RCD (Comply with local regulation)		
⑧		63A/230V manual changeover switch*		

*The manual changeover switch should be prepared by users separately. A 63A manual changeover switch is required for the whole home backup scenario. When switching to "LOAD" using the changeover switch, household loads will be supplied by the PV installation and battery. When the inverter is faulty or undergoing maintenance, switch to "GRID" to ensure the loads can work normally.

Backup Wiring Diagram TT System

The following diagram is an example for grid systems without special requirement on wiring connection.

Loads Connected to the Grid:

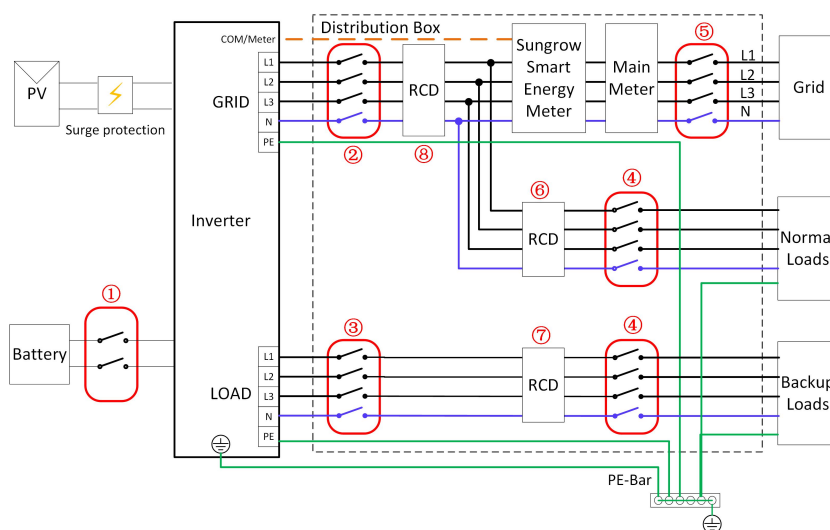

NO.	SH5/6T	SH8/10/12T	SH15T	SH20/25T
①	63A/800V DC breaker *			
②	≥25A/400V TypeB AC breaker	≥32A/400V TypeB AC breaker	≥40A/400V TypeB AC breaker	≥63A/400V TypeB AC breaker
③	Depends on loads			
④	Depends on loads			
⑤	Depends on household loads and inverter capacity			
⑥⑦	30mA RCD (Comply with local regulation)			
⑧	300mA RCD (Comply with local regulation)			

1. *If the battery is integrated with a readily accessible internal DC breaker, no additional DC breaker is required.

2. The values in the table are recommended values and can be set to other values according to actual conditions.

3. To improve the safety of the system, set the "Import Power Limit" for the inverter immediately after completing the wiring. The formula used to calculate the import power limit should be: Set value of Import Power Limit (kW) $\leq 3 \times 230 \times 0.8 \times$ rated current of the house's main switch. For instructions on parameter setting, see "8.10.16 Import Power Limit".

Whole Home Backup Wiring Diagram TT System

The following diagram is an example for grid systems without special requirement on wiring connection.

Whole Home Backup:

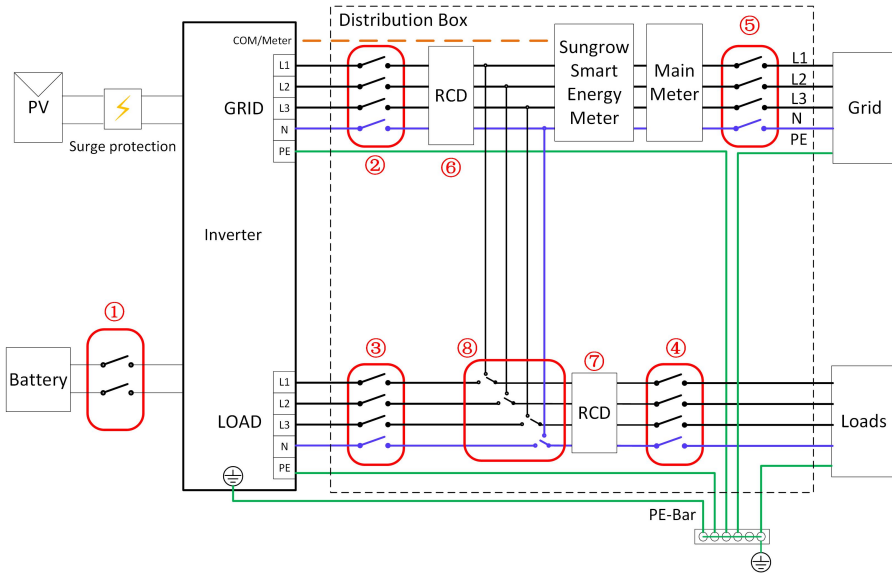

NO.	SH5/6T	SH8/10/12T	SH15T	SH20/25T
①	63A/800V DC breaker			
②	≥63A/400V TypeB AC breaker			
③	Depends on loads			
④	Depends on loads			
⑤	Depends on household loads and inverter capacity			
⑥	300mA RCD (Comply with local regulation)			
⑦	30mA RCD (Comply with local regulation)			
⑧	63A/230V manual changeover switch*			

*The manual changeover switch should be prepared by users separately. A 63A manual changeover switch is required for the whole home backup scenario. When switching to "LOAD" using the changeover switch, household loads will be supplied by the PV installation and battery. When the inverter is faulty or undergoing maintenance, switch to "GRID" to ensure the loads can work normally.

6.4 External Protective Grounding Connection

DANGER

- There are large currents during the inverter's operation. If the inverter is powered on and put into operation without being grounded, it may lead to electric shock hazards or failures of major protective functions such as surge protection. Therefore, before powering on the inverter, make sure it has been reliably grounded; otherwise, damages caused therefrom will not be covered by warranty.
- When performing electrical connections of the inverter, give the highest priority to grounding. Be sure to carry out the grounding connection first.

WARNING

- Since the inverter is not equipped with a transformer, neither the negative electrode nor the positive electrode of the PV string can be grounded. Otherwise, the inverter will not operate normally.
- Connect the grounding terminal to the external protective grounding point before AC cable connection, PV string connection, and communication cable connection.
- The external protective grounding point provides a reliable ground connection. Do not use an improper grounding conductor for grounding, Otherwise, it may cause product damage or personal injury.
- Depending on Local Rules, please also ground the PV panel subconstruction to the same common grounding point (PE Bar) in addition to local lightning protection rules.

WARNING

The external protective grounding terminal must meet at least one of the following requirements.

- The cross-sectional area of the grounding cable is not less than 10 mm² for copper wire or 16 mm² for aluminum wire. It is recommended that both the external protective grounding terminal and the AC side grounding terminal be reliably grounded.
- If the cross-sectional area of the grounding cable is less than 10 mm² for copper wire or 16 mm² for aluminum wire, ensure that both the external protective grounding terminal and the AC side grounding terminal are reliably grounded.

The grounding connection can be made by other means if they are in accordance with the local standards and regulations, and SUNGROW shall not be held liable for the possible consequences.

6.4.1 External Protective Grounding Requirements

All non-current carrying metal parts and device enclosures in the PV power system should be grounded, for example, brackets of PV modules and inverter enclosure.

When there is only one inverter in the PV system, connect the external protective grounding cable to a nearby grounding point.

When there are multiple inverters in the PV system, connect the external protective grounding terminals of all inverters and the grounding points of the PV module brackets to ensure equipotential connections to ground cables (according to the onsite conditions).

6.4.2 Connection Procedure

step 1 Prepare the cable and OT/DT terminal.

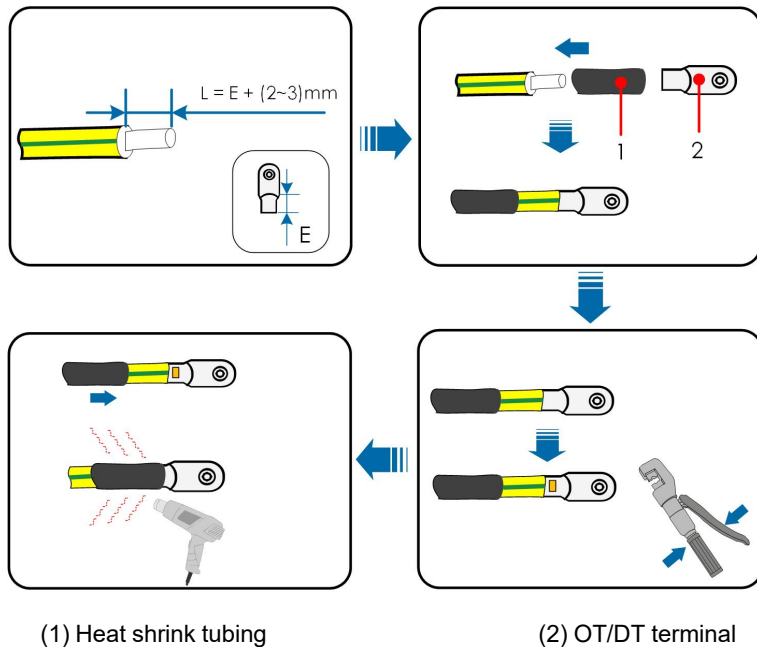

After being crimped, the OT terminal must wrap the wires completely, and the wires must contact the OT terminal closely.

When using a heat gun, protect the device from being scorched.

step 2 Remove the screw on the grounding terminal and fasten the cable with a screwdriver.

step 3 Apply paint to the grounding terminal to ensure corrosion resistance.

-- End

6.5 AC Cable Connection

6.5.1 AC Side Requirements



Only with the permission of the local grid department, the inverter can be connected to the grid.

Before connecting the inverter to the grid, ensure the grid voltage and frequency comply with requirements, for which, refer to "**Technical Data**". Otherwise, contact the electric power company for help.

WARNING

AC circuit breakers should be installed on the output side of the inverter and the grid side to ensure safe disconnection from the grid.

- **Determine whether an AC circuit breaker with greater overcurrent capacity is required based on actual conditions.**
- **Multiple inverters cannot share one AC circuit breaker.**

Residual Current Monitoring Device

With an integrated universal current-sensitive residual current monitoring unit included, the inverter will disconnect immediately from the mains power once a fault current with a value exceeding the limit is detected.

6.5.2 Installing the AC Connector

The inverter's GRID and LOAD terminals are integrated into one port, as shown below.

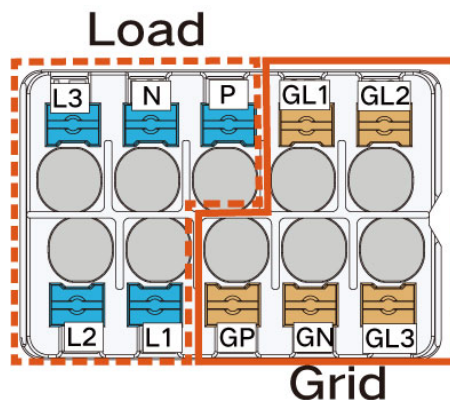

There are two different markings for the AC wiring terminals, one is the combination of GR, GS, GT, LR, LS, and LT, and the other is the combination of GL1, GL2, GL3, L1, L2, and L3 (as shown above). The actual product should take precedence.

For the GRID terminals, GL1, GL2, and GL3 indicate live wires, GN indicates N wire, and GP indicates ground wire.

For the LOAD terminals, L1, L2, and L3 indicate live wires, N indicates N wire, and P indicates ground wire.

step 1 Unscrew the swivel nut of the AC connector.

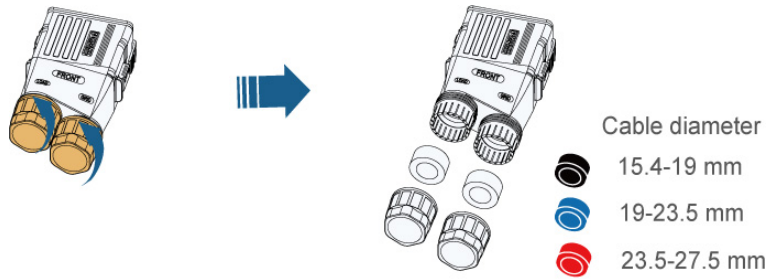

step 2 Take out the terminal plug from the housing.

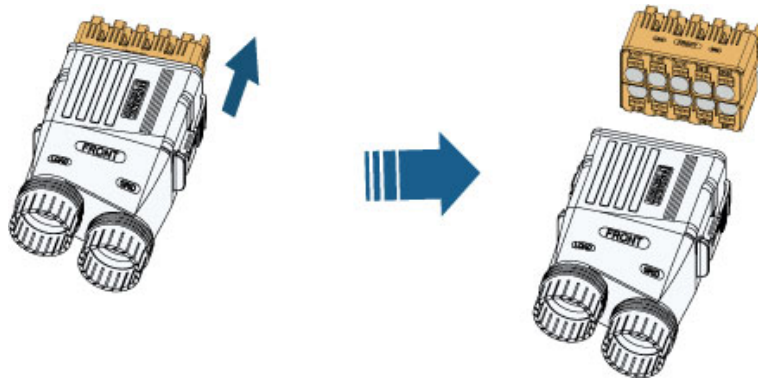

step 3 Thread the AC cable of appropriate length through the swivel nut and the housing.

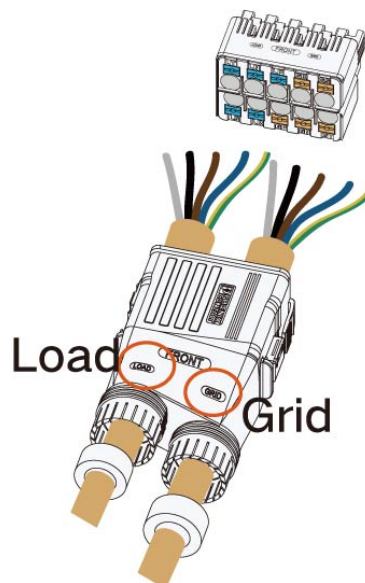

- step 4 Strip the cable by 80 mm. If the cold-pressed terminal is to be crimped onto the cable, the cable stripping length should be 2~3 mm plus the length of the metal body of the terminal. If the cold-pressed terminal is not used, strip the cable by 14~16 mm.

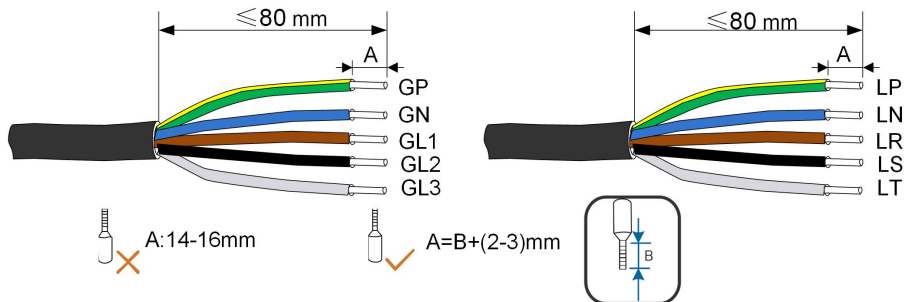

The color of the cable cores in the figure is for reference only, and cables or cable cores selected must meet local standards.

- step 5 **(Optional)** If the number of cable wires (n) > 7 , use cold-pressed terminals for cable crimping. If $n \leq 7$, skip this step.

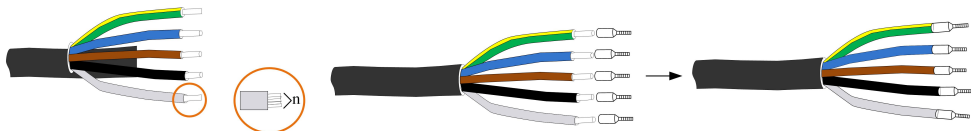

Select appropriate cord end terminal according to the cable cross-section area.

- step 6 When wiring, the five wires (LOAD or GRID) should be correctly positioned according to the marks and inserted into the terminal at the same time. After finishing wiring, make sure the cold-pressed terminal does not protrude from the outside surface of the AC terminal.

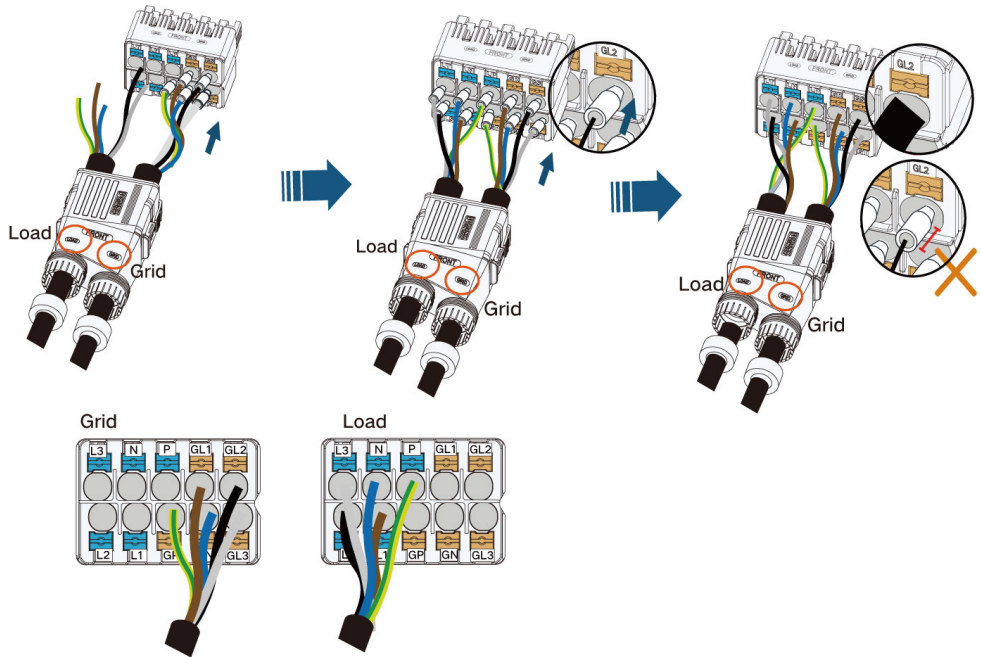

WARNING

When performing AC wiring (LOAD or GRID), check carefully if the cable wires match the ports properly. Incorrect wiring will damage the inverter.

step 7 Ensure that the wires are securely in place by slightly pulling them. Tighten the swivel nut to the housing.

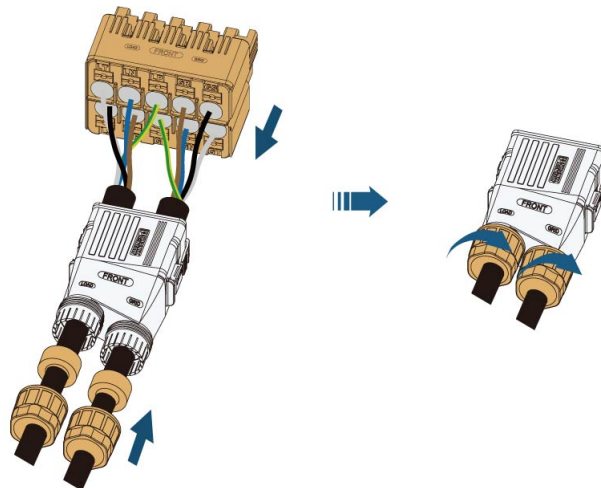

step 8 Insert the AC connector into the **GRID and LOAD** terminal on the inverter until there is an audible sound.

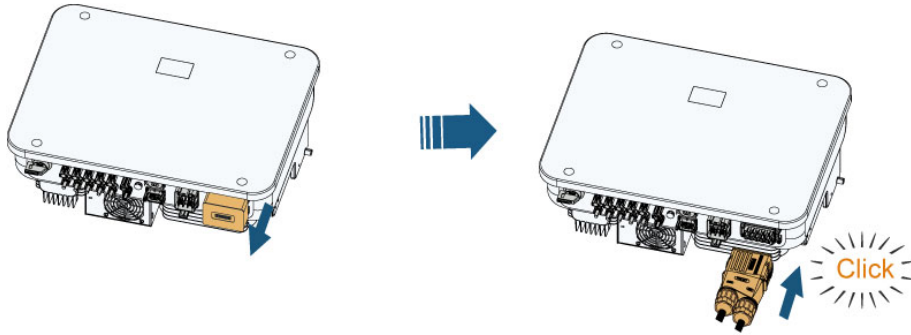

⚠ DANGER

High voltage may be present in inverter!

Ensure all cables are voltage-free before electrical connection.

Do not connect the AC circuit breaker until all inverter electrical connections are completed.

step 9 Lock the AC connector using a slotted screwdriver.

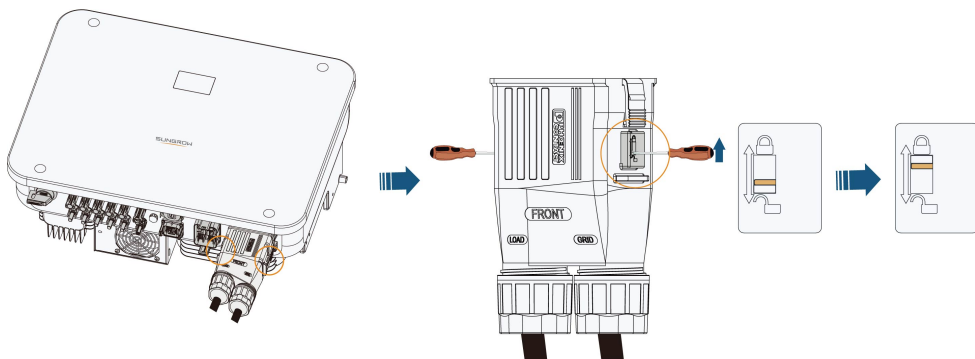

-- End

6.6 DC Cable Connection

⚠ DANGER

The PV string will generate lethal high voltage when exposed to sunlight.

- **Respect all safety instructions listed in relevant documents about PV strings.**

⚠ WARNING

- **Make sure the PV array is well insulated to ground before connecting it to the inverter.**
- **Make sure the maximum DC voltage and the maximum short circuit current of any string never exceed inverter permitted values specified in "Technical Data".**
- **Check the positive and negative polarity of the PV strings, and connect the PV connectors to corresponding terminals only after ensuring polarity correctness.**
- **During the installation and operation of the inverter, please ensure that the positive or negative electrodes of PV strings do not short-circuit to the ground. Otherwise, an AC or DC short-circuit may occur, resulting in equipment damage. The damage caused by this is not covered by the warranty.**
- **Electric arc or contactor over-temperature may occur if the DC connectors are not firmly in place, and the loss caused is not covered by the warranty.**
- **If the DC input cables are reversely connected or the positive and negative terminals of different MPPT are shorted to ground at the same time, while the DC switch is in the "ON" position, do not operate immediately. Otherwise, the inverter may be damaged. Please turn the DC switch to "OFF" and remove the DC connector to adjust the polarity of the strings when the string current is lower than 0.5 A.**
- **Use the DC connectors supplied with the product for DC cable connection. Using incompatible DC connectors may result in serious consequences, and the device damage is not covered under warranty.**
- **Inverters do not support full parallel connection of strings (Full parallel connection refers to a connection method in that strings are connected in parallel and then connected to the inverter separately).**
- **Do not connect one PV string to multiple inverters. Otherwise, the inverters may be damaged.**

NOTICE

The following requirements about PV string connection must be met. Otherwise, it may cause irreversible damage to the inverter, which is not covered by the warranty.

- **Mixed use of PV modules of different brands or models in one MPPT circuit, or PV modules of different orientation or inclination in a string may not damage inverter, but will cause system bad performance!**

6.6.1 PV Input Configuration



Note: The output voltage of strings should all exceed the lower limit of the full load MPPT voltage range.

For SH5/6/8T, each PV input operates independently and has its own MPPT. In this way, string structures of each PV input may differ from each other, including PV module type, number of PV modules in each string, angle of tilt, and installation orientation.

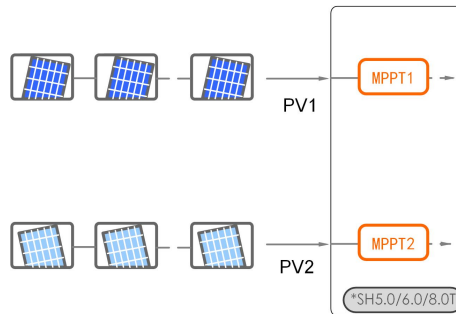

For SH10/12T, each pair of PV terminals is corresponding to an independent PV string. PV input PV1, PV2 connect to MPPT1 and PV3 connect to MPPT2. For the best use of PV power, PV1 and PV2 should be the same in PV string structure, including the type, number, tilt, and orientation of the PV modules.

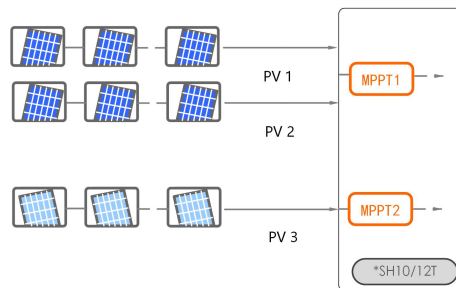

For SH15T/20/25T, each pair of PV terminals is corresponding to an independent PV string. PV input PV1, PV2 connect to MPPT1, PV3, PV4 connect to MPPT2 and PV5 connect to MPPT3. For the best use of PV power, PV1 and PV2, PV3 and PV4 should be the same in PV string structure, including the type, number, tilt, and orientation of the PV modules.

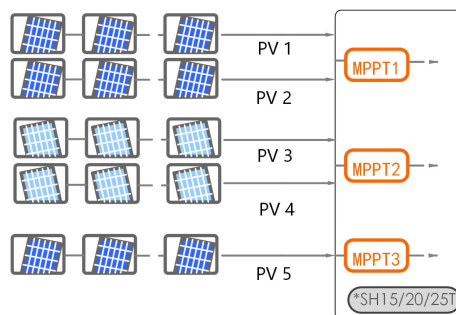

Prior to connecting the inverter to PV inputs, the following electrical specifications must be met simultaneously:

Model	Open-circuit Voltage Limit	Max. current for Input Connector
SH5/6/8/10/12/15/20/ 25T	1000 V	30 A

6.6.2 Installing the PV Connectors

⚠ DANGER

High voltage may be present in the inverter!

- **Ensure all cables are voltage-free before performing electrical operations.**
- **Do not connect the DC switch and AC circuit breaker before finishing electrical connection.**



To ensure IP65 protection, use only the supplied connector.

step 1 Strip the insulation from each DC cable by 7 mm–8 mm.

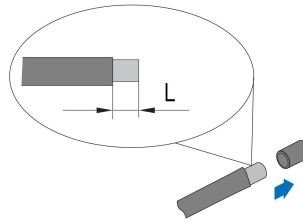

step 2 Assemble the cable ends with the crimping pliers.

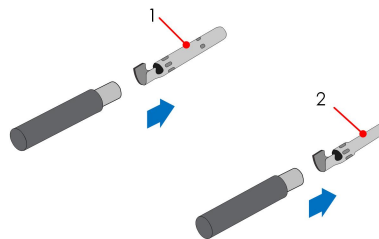

1: Positive crimp contact

2: Negative crimp contact

step 3 Lead the cable through cable gland, and insert the crimp contact into the insulator until it snaps into place. Gently pull the cable backward to ensure firm connection. Tighten the cable gland and the insulator (torque 2.5 N.m to 3 N.m).

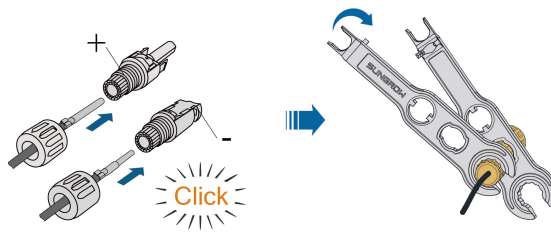

step 4 Check for polarity correctness.

NOTICE

If the PV polarity is reversed, the inverter will be in a fault or alarm state and will not operate normally.

step 5 Rotate the DC switch to "OFF" position.

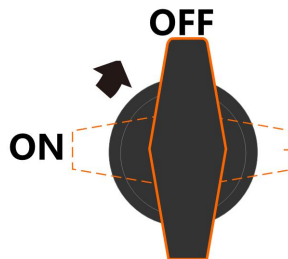

step 6 Check the cable connection of the PV string for polarity correctness and ensure that the open circuit voltage in any case does not exceed the inverter input limit of 1,000V.

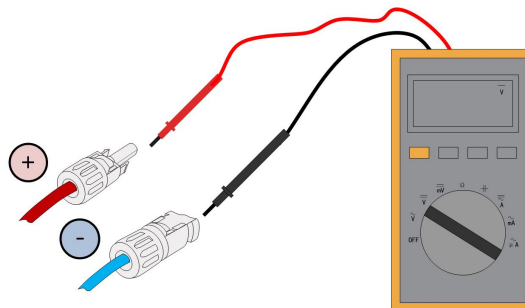

step 7 Connect the PV connectors to corresponding terminals until there is an audible click.

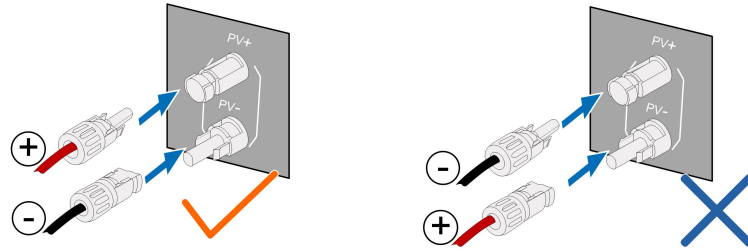

step 8 Follow the foregoing steps to connect PV connectors of other PV strings.

step 9 Seal any unused PV terminal with a terminal cap.

-- End

6.7 Battery Power Connection

6.7.1 Battery Connection Requirements

This section mainly describes the cable connections on the inverter side. Refer to the instructions supplied by the battery manufacturer for the connections on the battery side and configuration.

⚠ WARNING

Only use properly insulated tools to prevent accidental electric shock or short circuits. If insulated tools are not available, use electrical tape to cover the entire exposed metal surfaces of the available tools except their tips.

⚠ WARNING

The plug connector must be connected only by trained electricians.

⚠ WARNING

Do not disconnect under load!
Battery connectors must not be disconnected while under load. They can be placed in a no load state by shutting down the inverter completely.

⚠ WARNING

During the installation and operation of the inverter, please ensure that the positive or negative polarities of batteries do not short-circuit to the ground. Otherwise, an AC or DC short-circuit may occur, resulting in equipment damage. The damage caused by this is not covered by the warranty.

If the hybrid inverter is not connected to a battery, it will not support reliably the backup function.



The battery should be connected to the common grounding of the house (PE Bar) rather than directly to the inverter PE.

The energy in the battery will not backfeed into the PV modules.

6.7.2 Installing the Battery Connector



The connector type is subject to the actual received device.

step 1 Strip the insulation from each DC cable by 7~8 mm.

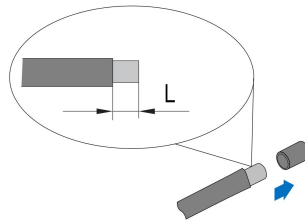

step 2 Assemble the cable ends with the crimping pliers.

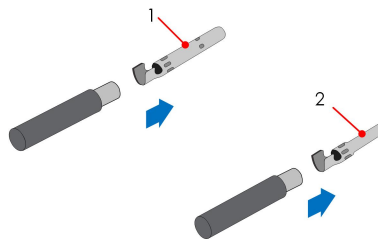

1: Positive crimp contact

2 : Negative crimp contact

step 3 Lead the cable through cable gland, and insert the crimp contact into the insulator until it snaps into place. Gently pull the cable backward to ensure firm connection.

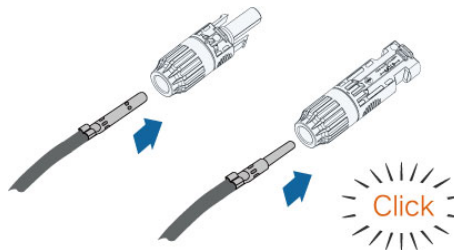

step 4 Tighten the cable gland and the insulator.

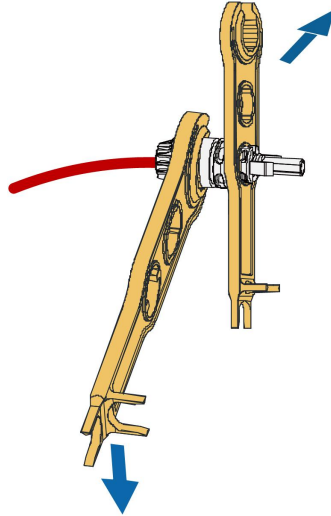

step 5 Check for polarity correctness.

step 6 Insert the connector into the **BAT+** and **BAT-** terminals.

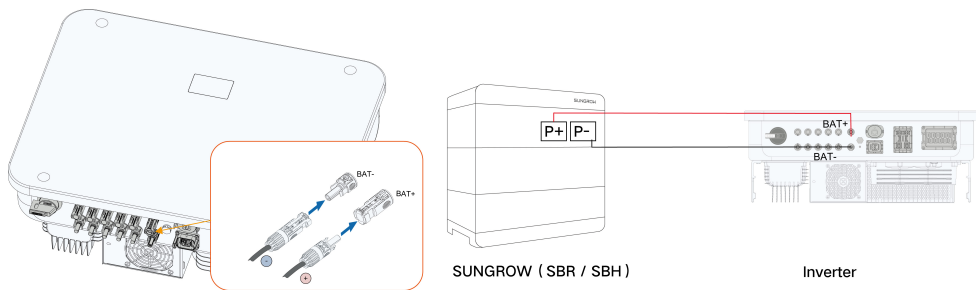

If another model of battery is used, please refer to the corresponding product manual.

-- End

6.8 Communication Connection

WLAN function

LAN function

Through the Modbus TCP/IP protocol, the EMS or the Logger from the third party can fully control the on/off, derating, charging and discharging of the inverter.

RS485 function

The RS485 communication interfaces are used to establish communication connection with monitoring devices.

6.8.1 WiNet-S2 Connection

The WiNet-S2 module supports Ethernet communication and WLAN communication. It is not recommended to use both communication methods at the same time.

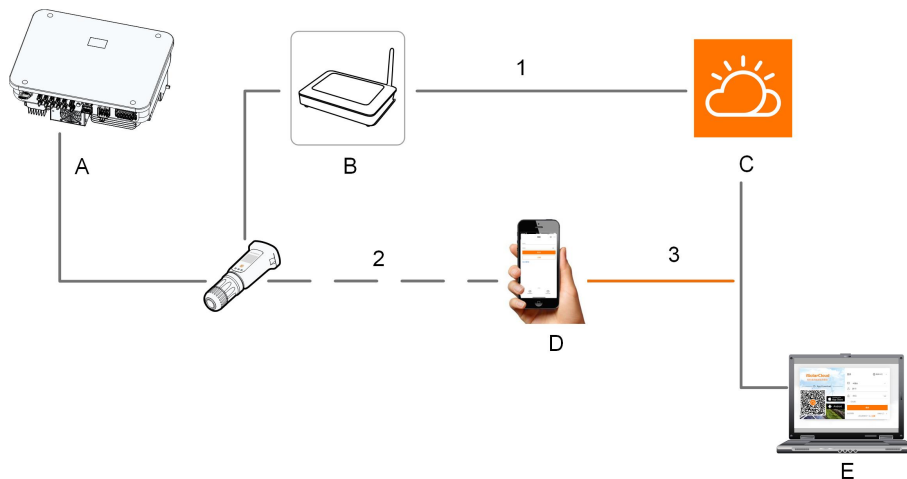

(A) Inverter

(B) Router/Switch

(C) iSolarCloud server

(D) iSolarCloud App

(E) iSolarCloud

(1) ——— Internet

(2) - - - - Local access

(3) ——— Remote

For details, see the quick guide for the WiNet-S2 module. Scan the following QR code for the quick guide.



6.8.1.1 WLAN Communication

step 1 Remove the waterproof lid from the **WLAN** terminal.

step 2 Install the module. Slightly shake it by hand to determine whether it is installed firmly, as shown below.

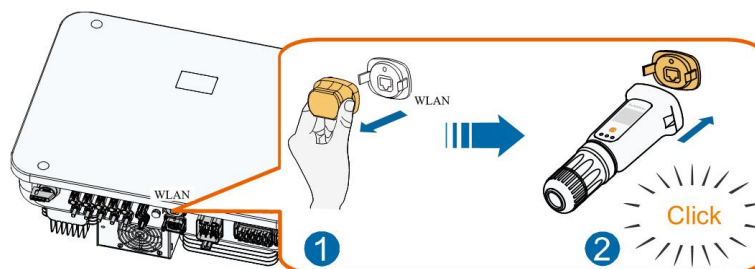

step 3 Refer to the guide delivered with the module for the set-up.

-- End

6.8.1.2 Ethernet Communication

step 1 **(Optional)** Strip the insulation layer of the communication cable with an Ethernet wire stripper, and lead the corresponding signal cables out. Insert the stripped communication cable into the RJ45 plug in the correct order, and crimp it with a crimper.

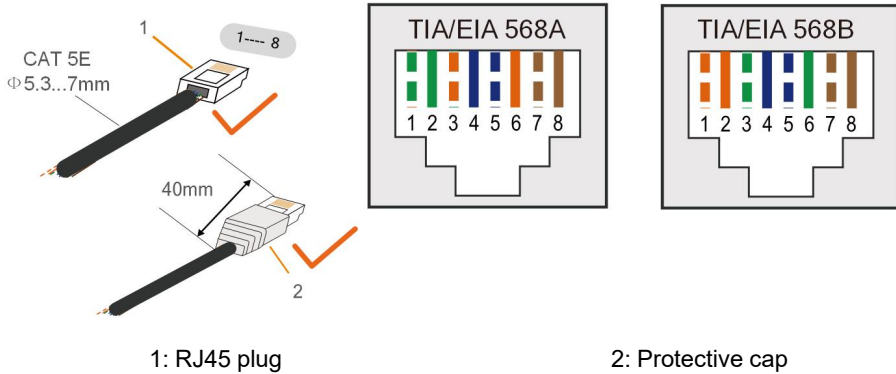

Skip this step if a standard network cable with RJ45 plug is prepared.

step 2 Unscrew the swivel nut from the communication module and take out the inner sealing ring.

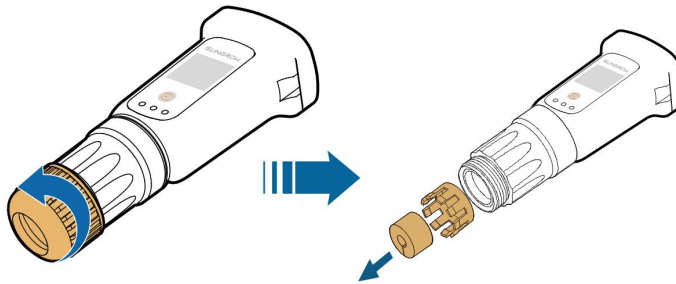

step 3 Unscrew the housing from the communication module.

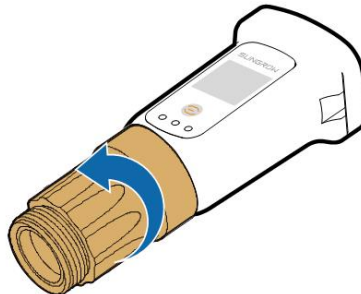

step 4 Thread the network cable through the swivel nut and gasket. Afterwards, route the cable into the opening of the sealing. Finally, insert the cable through the housing.

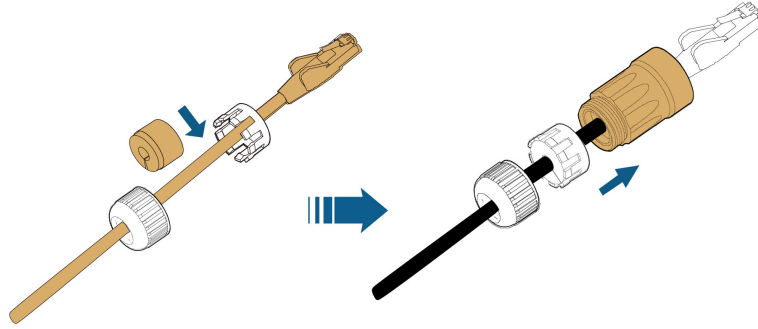

step 5 Insert the RJ45 plug into the front plug connector until there is an audible click and tighten the housing. Install the gasket and fasten the swivel nut.

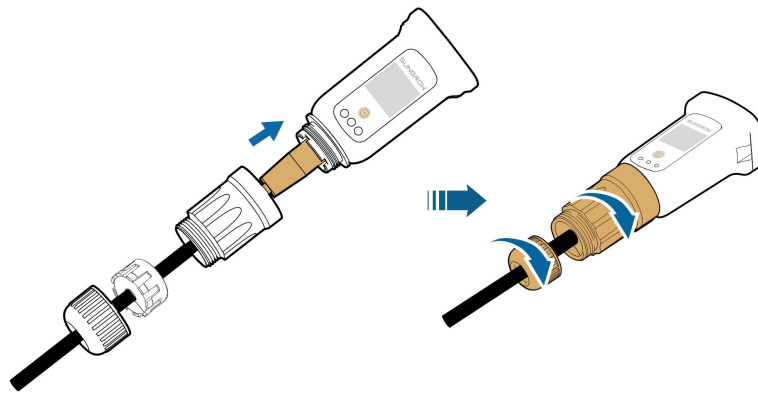

step 6 Remove the waterproof lid from the **WLAN** terminal and install WiNet-S.

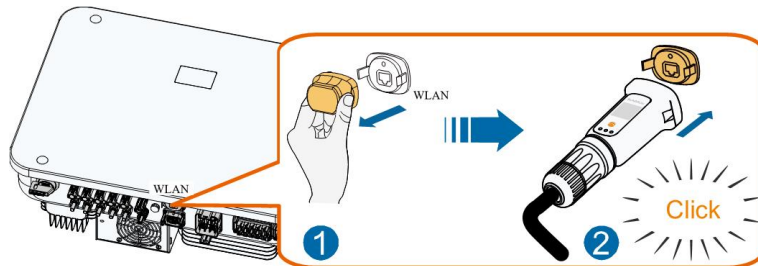

step 7 Slightly shake it by hand to determine whether it is installed firmly.

-- End

6.8.2 COM2 Terminal Communication Connection

COM2 terminal is used for establishing RS485 communication with devices such as the meter and battery. For more details, see "[6.2 Terminal Description](#)"

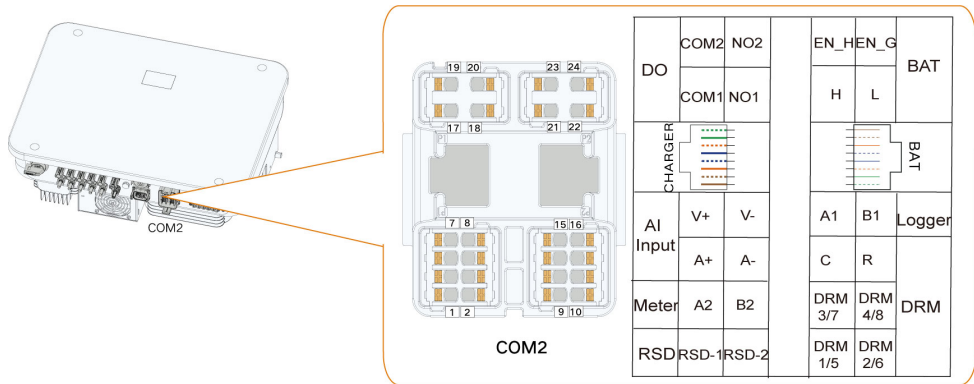

6.8.2.1 Smart Energy Meter Connection

The Smart Energy Meter is mainly used to detect the direction and magnitude of the current. The Smart Energy Meter DTSU666–20 is used (provided in the box), please connect Pin A on the meter to Pin A2 on the inverter and Pin B on the meter to Pin B2 on the inverter.

Contact SUNGROW to ensure that the Smart Energy Meter model is available locally.

The meter data may not be used for billing purposes.



The inverter is equipped with the feed-in power limit function, so as to meet the requirements of some national standards or grid standards for the output power at the grid connection point. The export control functionality has not been tested to AS/NZS 4777.2:2020.

Smart Energy Meter Wiring Diagram

The Smart Energy Meter wiring diagram is presented as follows:

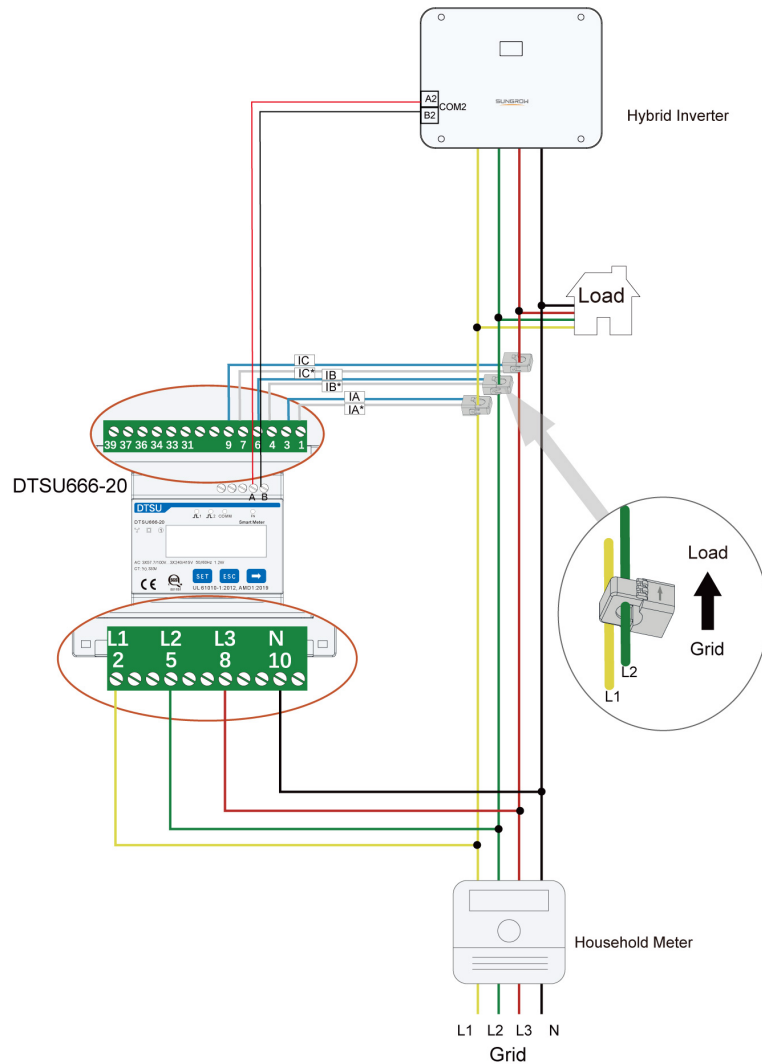
**NOTICE**

When wiring, make sure the arrow on the CT points in the direction from Grid to Load.

Steps for connecting the Smart Energy Meter to the inverter with a communication cable

1. Unscrew the swivel nut from the connector and take out the terminal block.

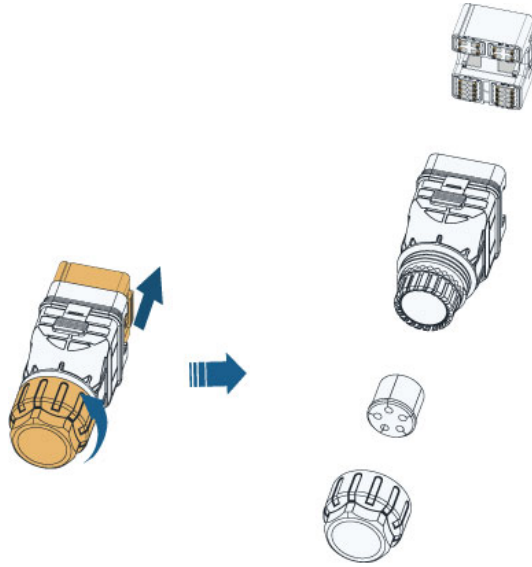

2. Remove the seal and lead the cable through the cable gland.

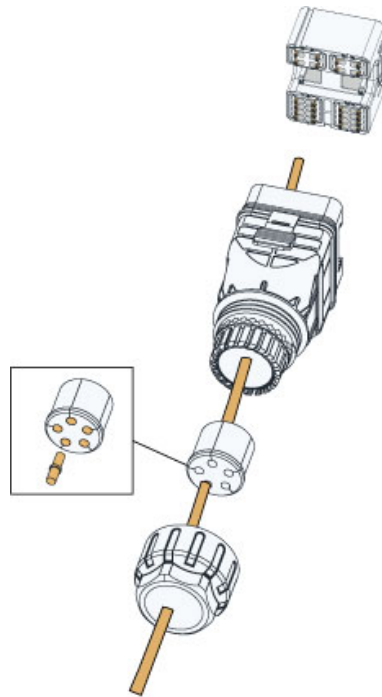

3. Remove the cable jacket and strip the wire insulation.

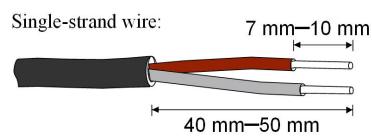

Multi-core multi-strand wire:

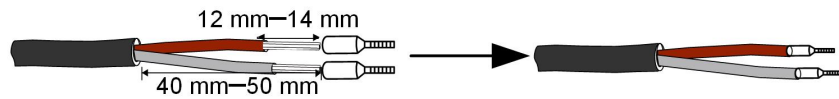

4. If the communication distance (L) ≤ 10 m, use a RS485 communication cable for connection directly. Plug the wires into the A2, B2 terminal of the COM2 terminal.

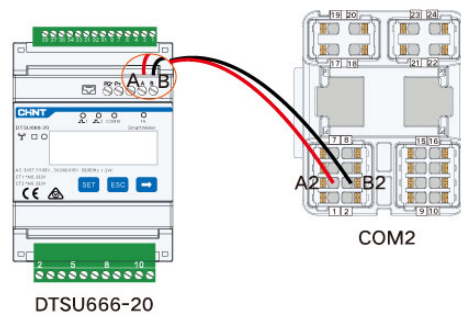
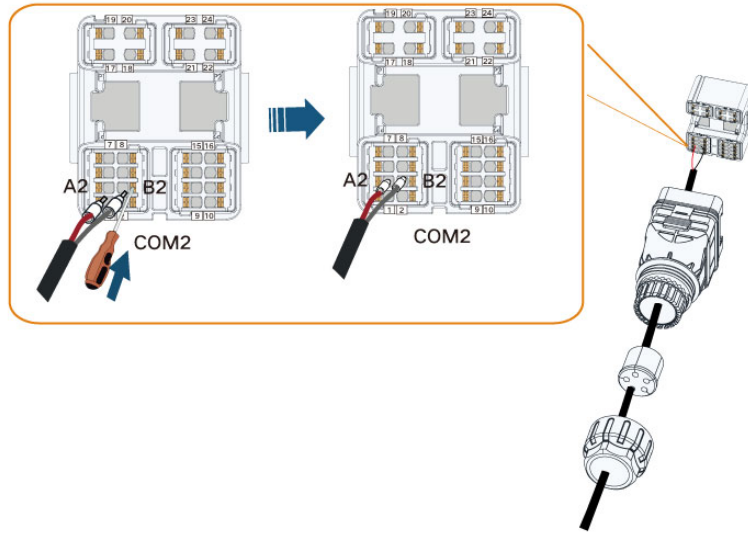

If $10\text{m} < L \leq 50\text{m}$, add an extra 120Ω resistor to improve the communication quality.

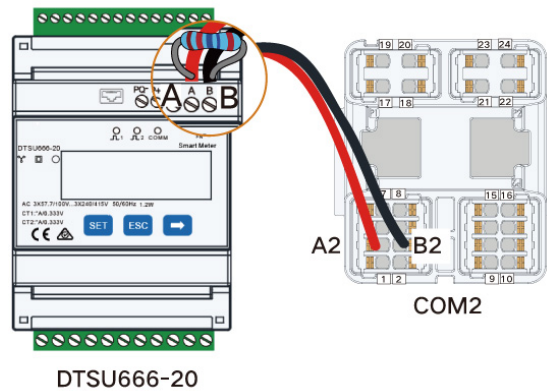

5. Insert the terminal block into the connector until it snaps into place with an audible click and fasten the swivel nut.

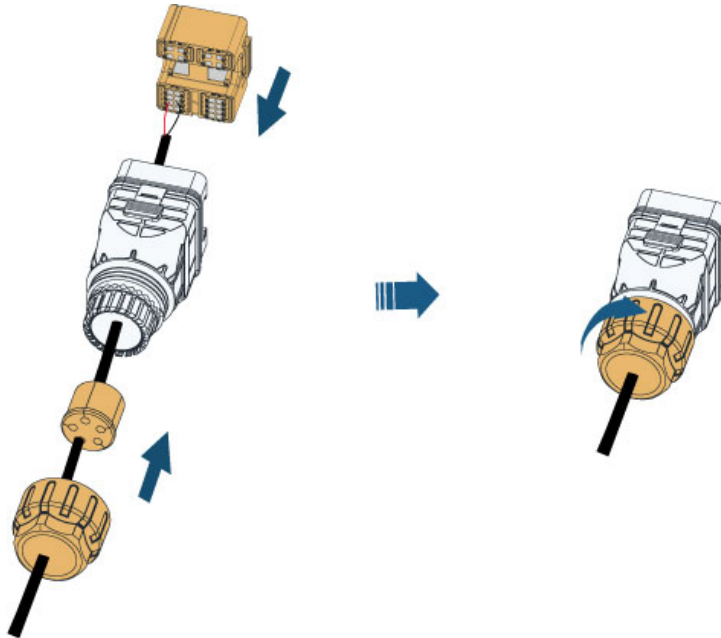

6. Remove the waterproof lid from the COM2 terminal, insert the COM2 connector into COM2 terminal of the inverter until there is an audible click.

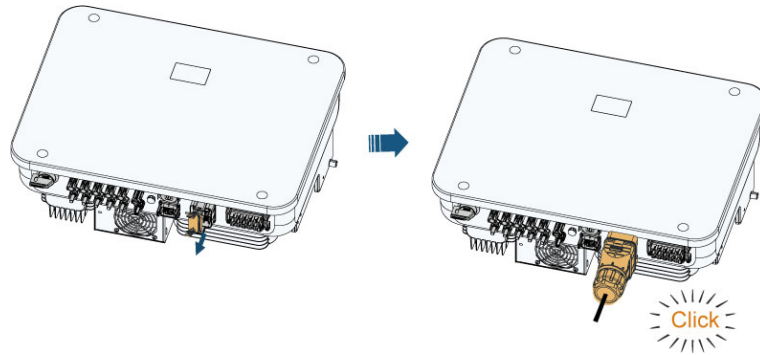
**NOTICE**

For more information about the Smart Energy Meter, please refer to the corresponding product manual.

**6.8.2.2 Battery Communication Connection**

Pin terminal or RJ45 plug can be used to connect the battery for communication.

Pin terminal connection

Battery

Inverter

1. For usage of COM2 connector, see "[6.8.2.1 Smart Energy Meter Connection](#)". Plug the wires into the H, L terminal of the COM2 terminal.

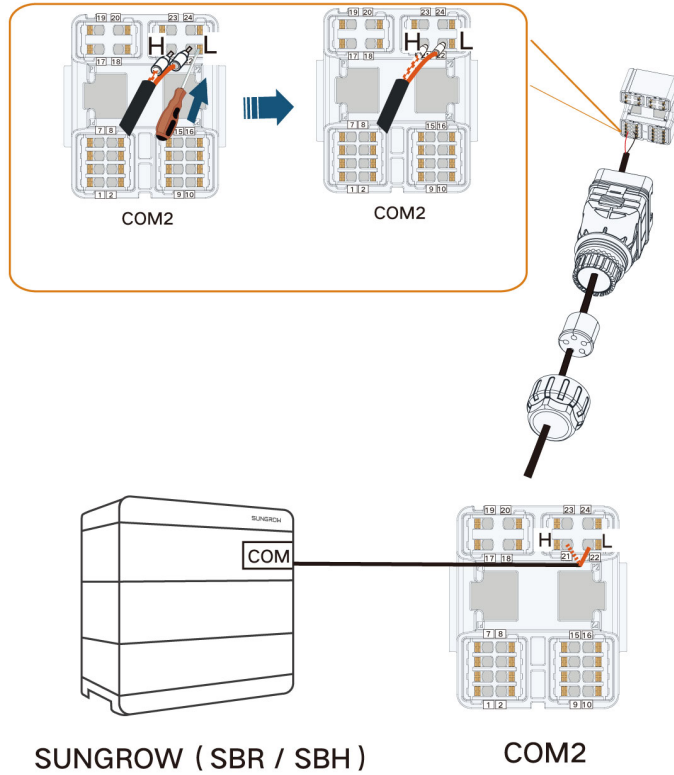

RJ45 connection



Battery

Inverter

1. Plug the wires into the RJ45–BAT terminal of the COM2 terminal.

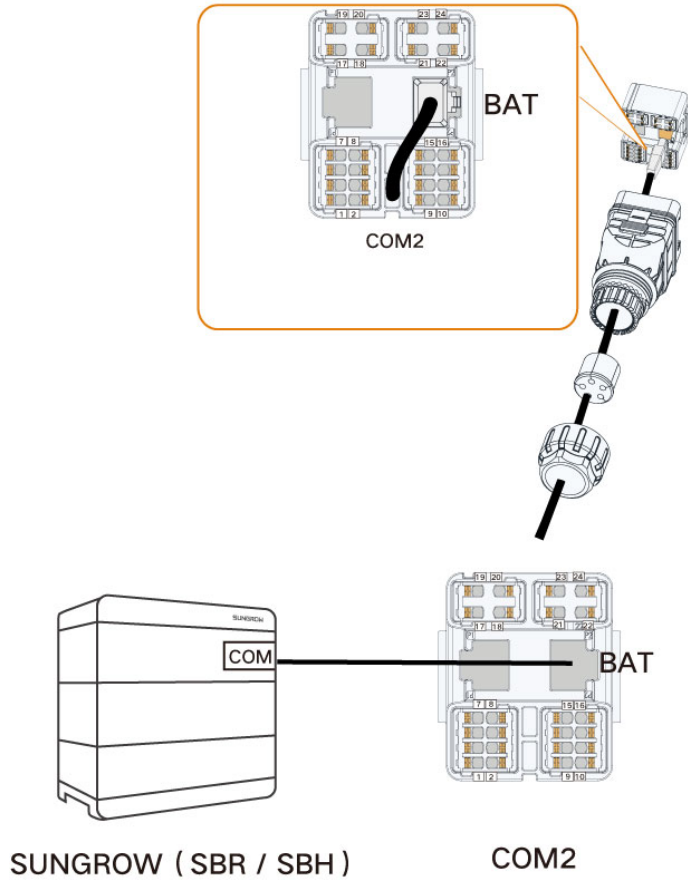
**NOTICE**

If another model of battery is used, please refer to the corresponding product manual.

6.8.2.3 DO Connection

The inverter has one DO relay with multiple functions as follows:

DO(COM1, NO1):

- Consumer load control. In this case the DO relay will control a contactor that will open or close in certain condition. Please choose the appropriate contactor according to the load power, e.g. the contactor types of the 3TF30 series from SIEMENS (3TF30 01- 0X).
- Earth fault alarm. In this case, the additional equipment required is a light indicator and/ or a buzzer.

DO(COM2, NO2):

- Diesel generator start/stop control. The inverter signals the DO port to close/open to start/stop the diesel generator.

Relay	Trigger condition	Description
Consumer load control	The load control mode has been set via the iSolarCloud App.	The relay is activated once the conditions of the control mode are satisfied. See "8.10.10 Load Control" .
Earth fault alarm	The earth fault occurs.	Once the inverter receives the earth fault signal, the relay closes the contact. The relay remains triggered until the fault is removed. See "8.10.13 Grounding Detection" .
Diesel generator start/stop control.	1. Force the diesel generator to start/stop 2. Start/stop the diesel generator based on battery SOC	/

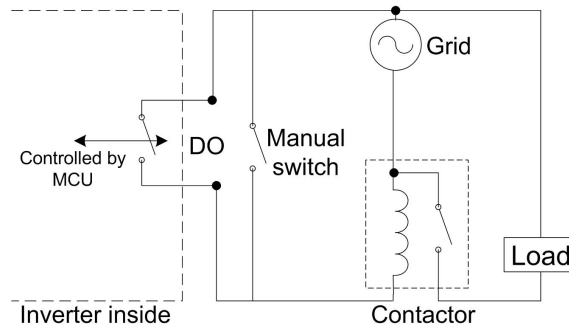

NOTICE

- A DC signal of max 30V/3A or an AC contactor must be installed between the inverter and appliances. It is forbidden to connect the load directly to the DO port.
- The current of the DO dry contact should not be larger than 3 A.
- The DO node is not controlled once the inverter is powered off. Connect the AC contactor by the manual switch, so as to control the loads.

Procedure

Plug the wires into the DO (COM1, NO1), DO (COM2, NO2) terminal of the COM2 terminal.

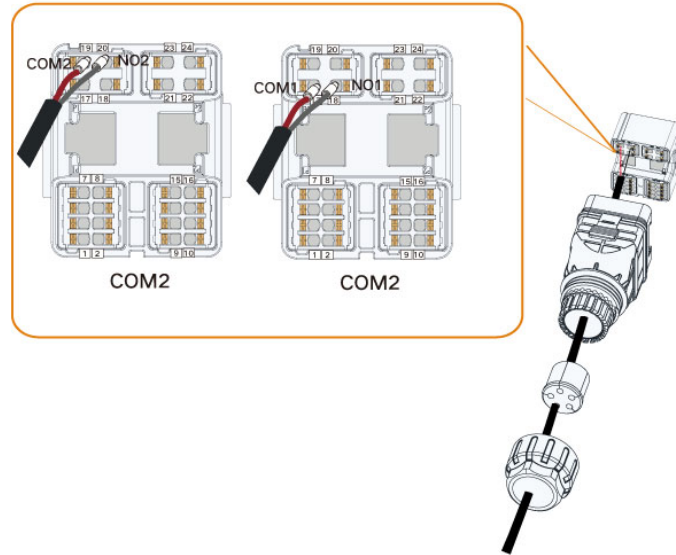

6.8.2.4 DRM Connection

DRM and Ripple Control support only one function at the same time.

DRM

The inverter supports the demand response modes as specified in the standard AS/NZS 4777. The inverter has integrated a terminal block for connecting to a DRED.

After the connection, the DRED asserts DRMs by shorting together terminals as specified in the table below.

table 6-6 Method of Asserting DRMs

Mode	Asserted by Shorting Terminals
DRM0	R & C
DRM1	D1/5 & C
DRM2	D2/6 & C
DRM3	D3/7 & C
DRM4	D4/8 & C
DRM5	D1/5 & R
DRM6	D2/6 & R
DRM7	D3/7 & R
DRM8	D4/8 & R

The inverter only supports DRM0 and the information is marked on the label located in the top of COM2 terminal.

Wiring between the inverter and the DRED is as follows.

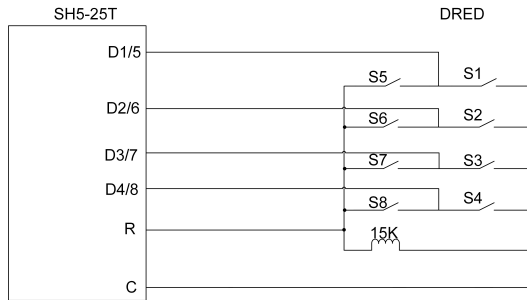

The switches that need to be closed in the state of DRM0 ~ DRM8 are shown in the table below.

Demand Response Mode	Operational Instruction	Switch state
DRM0	OI0	Close S1 and S5
DRM1	OI1	Close S1
DRM2	OI2	Close S2
DRM3	OI3	Close S3
DRM4	OI4	Close S4
DRM5	OI5	Close S5
DRM6	OI6	Close S6
DRM7	OI7	Close S7
DRM8	OI8	Close S8

Ripple Control

In Germany, the grid company uses the Ripple Control Receiver to convert the grid dispatching signal and send it as a dry contact signal.

Wiring of the ripple control receiver dry contact cables is shown in the figure below:

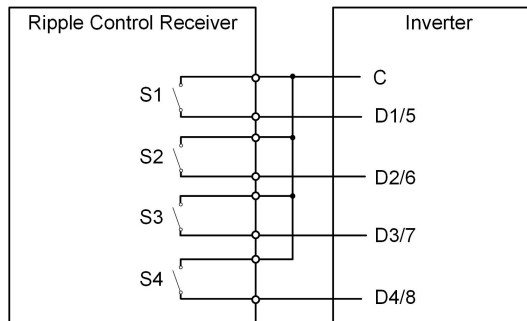

table 6-7 Method of Asserting DI Mode

S-1	S2	S3	S4	Switch Operation on External RCR	Output power (in % of the Rated AC output power)
0	0	0	0	None	100 % (configurable according to need)
1	0	0	0	Close S1	100 %

S-1	S2	S3	S4	Switch Operation on External RCR	Output power (in % of the Rated AC output power)
0	1	0	0	Close S2	60 %
0	0	1	0	Close S3	30 %
1	1	0	0	Close S1 and S2	0 % (disconnect from grid)

Procedure

Plug the wires into the corresponding terminal according the labels of the inverter

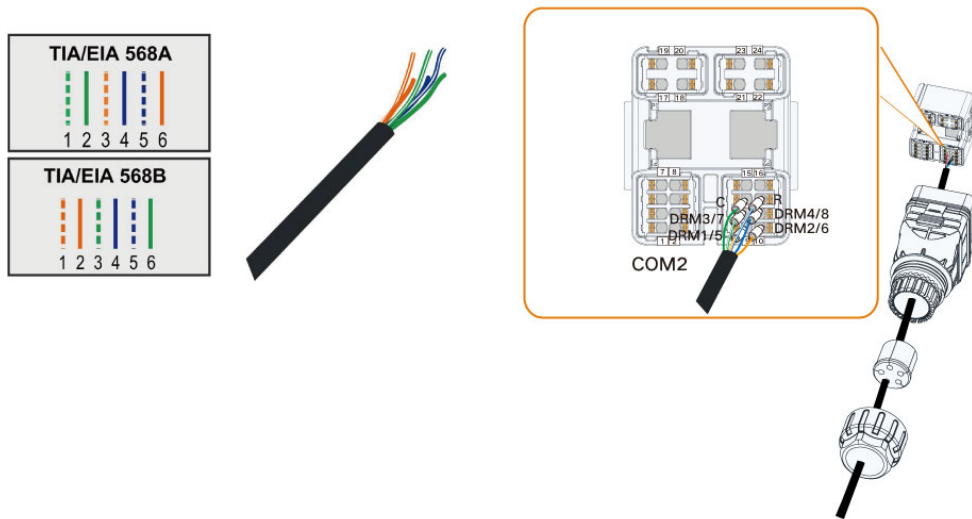

6.9 Protective Cover Installation (Optional)

NOTICE

Please install the protective cover after finishing all electrical connections of the inverter.

The installation procedure of the protective cover is as follows:

step 1 The protective cover consists of a left cover, a right cover and a top cover.

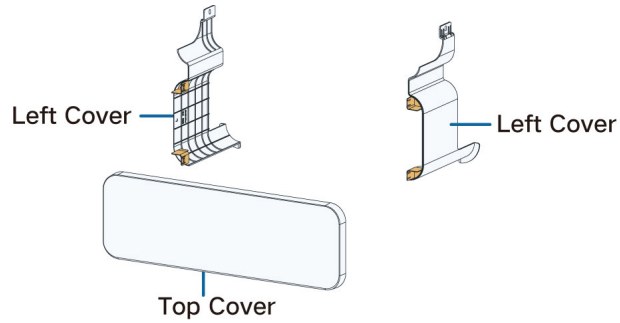

step 2 Slot the left cover and the right cover into the top cover until there is an audible "click".

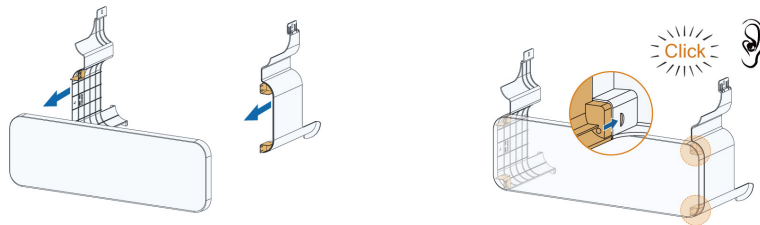

step 3 After the electrical connection of the inverter is completed, install the protective cover to the inverter bottom and make sure that the threaded holes in buckles of the protective cover are aligned with the holes on the sides of the inverter.

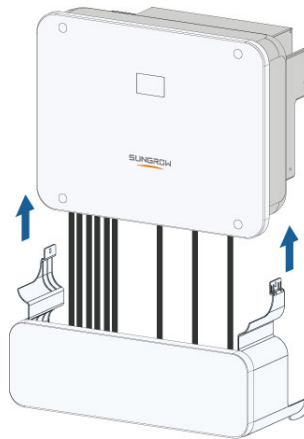

step 4 Use a screwdriver to secure screws with a torque of 1.5 N.m.

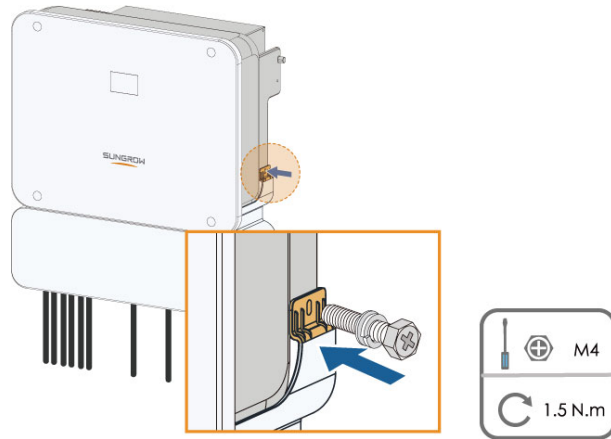

step 5 The installation of the protective cover is completed.

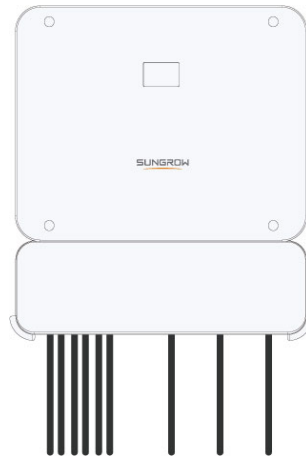

-- End

7 Commissioning/Startup Procedure

7.1 Inspection Before Commissioning

Check the following items before starting the inverter:

- All equipment has been reliably installed.
- DC switch(es) and AC circuit breaker are in the "OFF" position.
- The ground cable is properly and reliably connected.
- The AC cable is properly and reliably connected.
- The DC cable is properly and reliably connected.
- The communication cable is properly and reliably connected.
- The vacant terminals are sealed.
- No foreign items, such as tools, are left on the top of the machine or in the junction box (if there is).
- The AC circuit breaker is selected in accordance with the requirements of this manual and local standards.
- All warning signs & labels are intact and legible.

7.2 Commissioning Procedure

If all of the items mentioned above meet the requirements, proceed as follows to start up the inverter for the first time.

step 1 Connect the AC circuit breaker.

step 2 **(Optional)** Connect the external DC circuit breaker between the inverter and the battery pack if a battery is equipped.

step 3 **(Optional)** Power on the battery pack manually if a battery is equipped.

step 4 Rotate the DC switch to "ON". The DC switch may be integrated in the inverter or installed by the customer, wait for at least 5 minutes.

step 5 If the irradiation and grid conditions meet requirements, the inverter will normally operate. The connection time for inverter to grid may take some minutes or even to more according to different country code chosen in the initial settings and the real site grid condition.

step 6 Observe the LED indicator to ensure that the inverter operates normally. (Refer to ["2.4 LED Indicator"](#)).

-- End



- Strictly follow the preceding sequence. Otherwise, the product may be damaged, and the loss caused is not covered by the warranty.
- Before closing the AC circuit breaker between the inverter and the power grid, use a multimeter that is set to the AC gear to ensure that the AC voltage is within the specified range. Otherwise, the inverter may be damaged.

7.3 App Preparation

- step 1 Install the iSolarCloud App with latest version. Refer to "[8.2 Installing App](#)".
- step 2 Register an account. Refer to "[8.3 Account Registration](#)". If you have got the account and password from the distributor/installer or SUNGROW, skip this step.
- step 3 Download the firmware package to the mobile device in advance. Refer to "Firmware Update". This is to avoid download failure due to poor on-site network signal.

-- End

7.4 Creating a Plant

Prerequisites:

- The account and password for logging in to iSolarCloud App have been obtained from the distributor/installer or SUNGROW.
- The communication device is normally connected to the inverter.
- System positioning is enabled and iSolarCloud App is allowed to access location information.

- step 1 Open the App, tap  in the upper right corner of the interface, and select the correct access address.

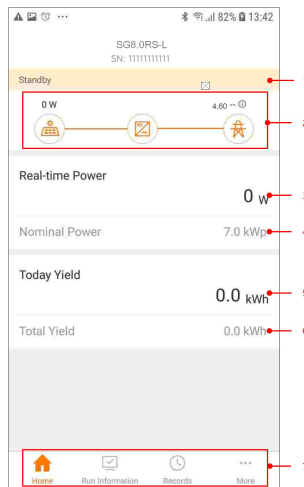

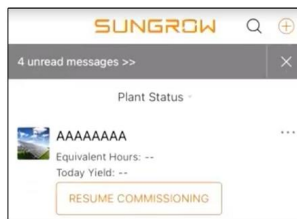

figure 7-1 Select Access Address

step 2 Enter the account and password on the login interface, and tap **LOGIN** to log in.

step 3 Tap  in the upper right corner to enter the plant creation interface.



step 4 Fill in the content according to actual needs, and the parameters containing * are required. Tap **Next** to enter the next interface.

figure 7-2 Plant Creation Settings

Parameter Name	Description
Plant name	The name of the plant.
Plant type	The type of the plant, which should be set corresponding to the actual plant type.
Installed power	The installed power of the plant.
Country/Region	The country/region where the plant is located.
Time zone	The time zone where the plant is located, which can be filled through automatic positioning and manual input.
Plant address	<p>The location of the plant, which can be filled in two ways:</p> <ul style="list-style-type: none"> Manually: Manually enter the plant location in the input box. Automatically: Tap  to automatically obtain the current location or search for the location of the plant, and then tap Confirm.

Parameter Name	Description
Grid-connection type	The way the plant is connected to the grid, including 100% Feed-in, Self-Consumption, Zero Export, and Off-grid.
Grid-connected date	The time when the plant is connected to the grid.
Owner's email address	Fill in the owner information of the plant, and both registered and un-registered email addresses are supported.
Postal code	The postal code of the place where the plant is located.
Plant image	Take photos of the plant and upload them.
Feed-in tariff	<p>The feed-in tariff can be set in two ways:</p> <ul style="list-style-type: none"> • Enter the feed-in tariff directly in the input box. • Tap More Configurations, select the tariff unit, enter the feed-in tariff, and tap Confirm. Enable Time-of-Use Tariff if needed. Tap Add Time-of-Use Tariff, add time intervals and price, and tap Confirm. Please note that if Time-of-use Tariff is enabled, the time periods shall cover 24 hours a day, and can not overlap.
Consumption tariff	<p>Set the consumption tariff as follows:</p> <ul style="list-style-type: none"> • Tap More Configurations, select the tariff unit, enter the consumption tariff, and tap Confirm. Enable Time-of-Use Tariff if needed, and refer to the setting methods of the feed-in tariff.

- step 5 Bind a device through scanning the QR code on the device, manually inputting the device S/N, or uploading a QR code picture. Tap **Confirm** after the QR code is identified or the S/N is verified.

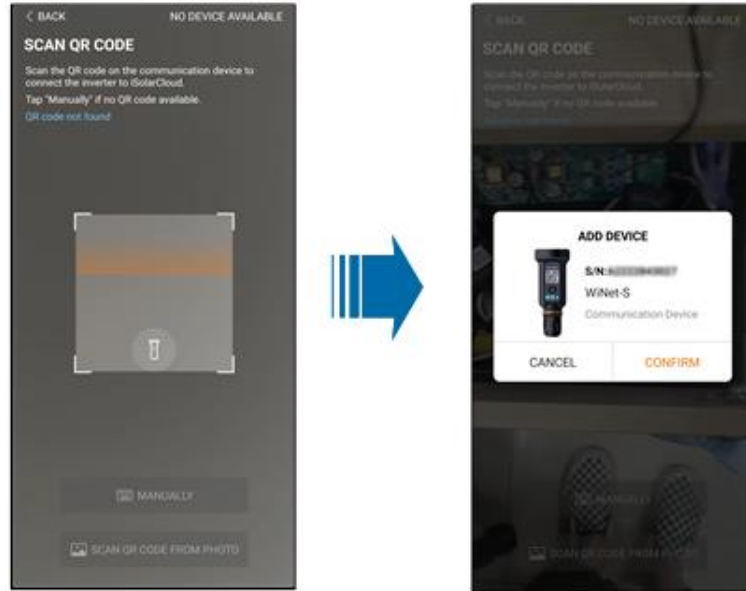

step 6 After a device is bound, tap **Device** and **Commissioning** to go to corresponding interface.

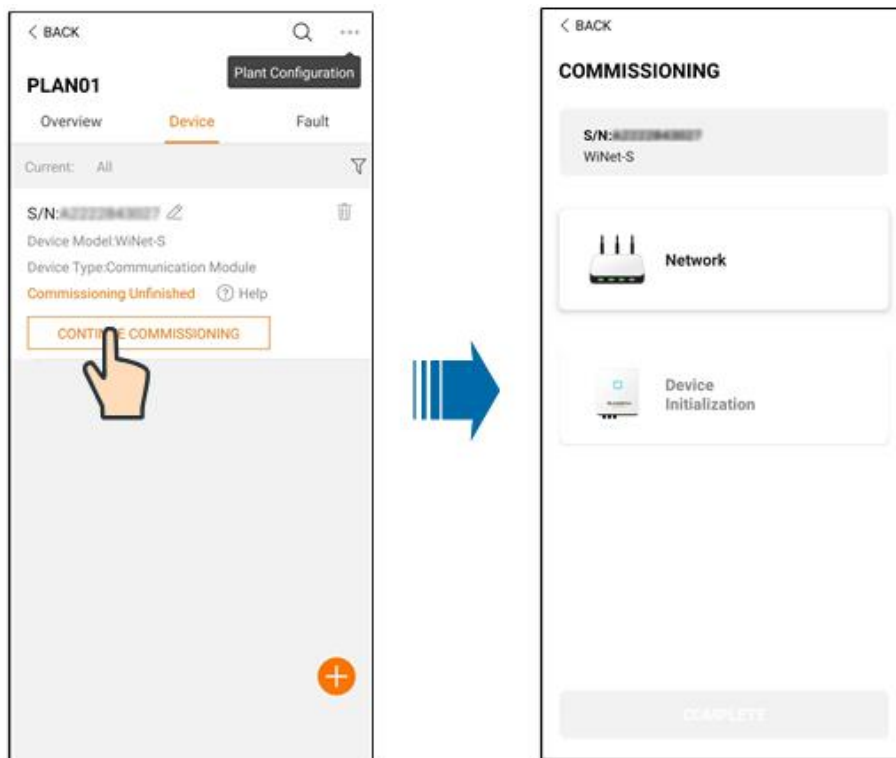

step 7 Tap **Network Configuration** to go to the **WLAN connection** interface. Tap the home network in the WLAN list, enter the password, and then tap **Confirm**.

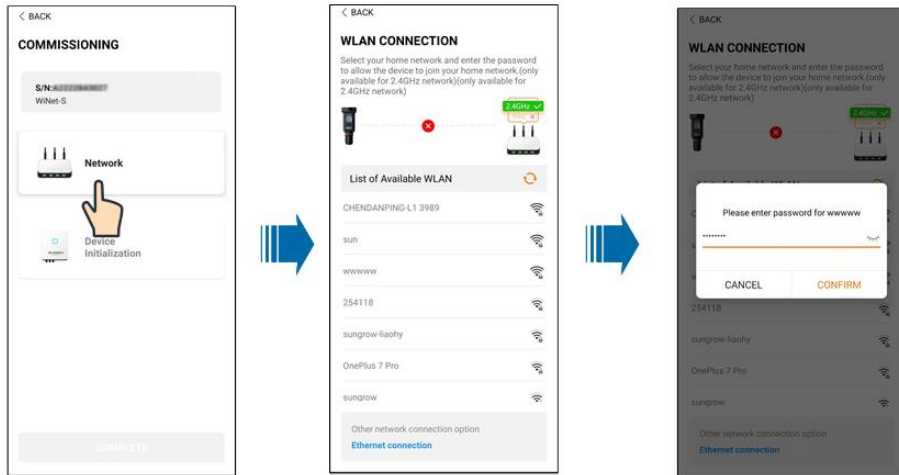

- step 8 Enter the **Activate EasyConnect** interface, and press the multi-function button on the WiNet-S2 to enable the Easyconnect mode according to the prompt on the screen. The App automatically enters a waiting processing interface if this mode is enabled, and automatically returns to the commissioning interface after the processing is completed.

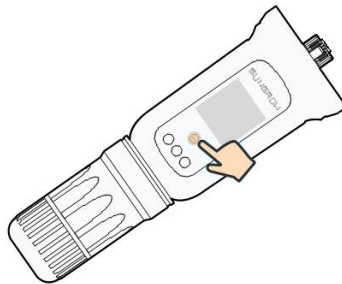

NOTICE

Only the 2.4 GHz working band is supported under the networking mode.
If the Easyconnect fails, please refer to other methods in the WiNet-S2 manual to establish the connection.

- step 9 Tap **Device Initialization** to go to the **Device initialization** interface. Set the initialization protection parameters as needed and tap **Settings** to return to the commissioning interface.

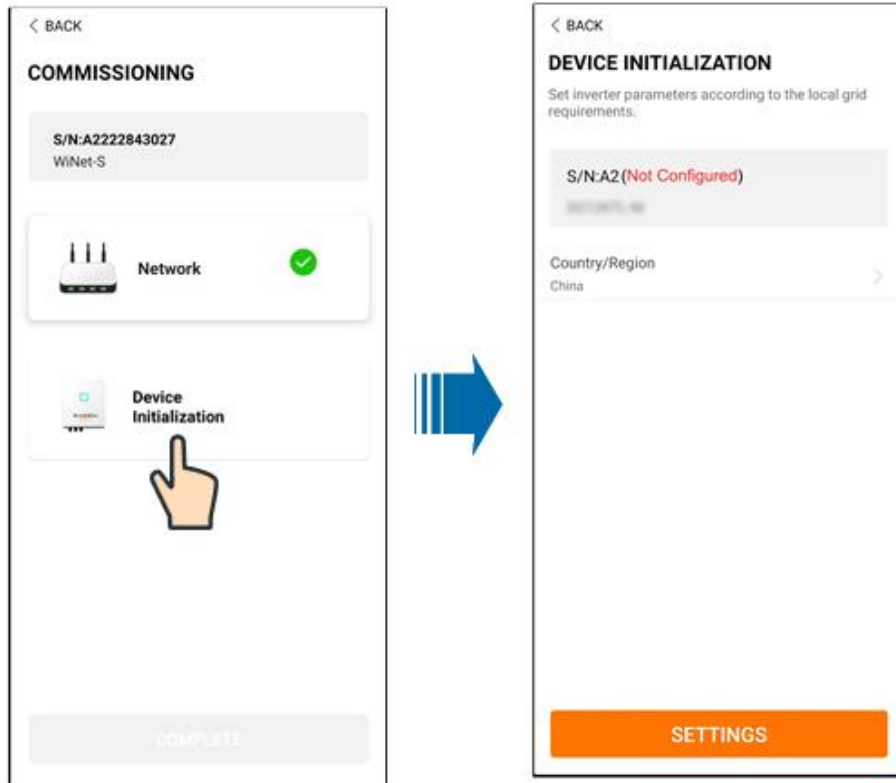

When the country is set to Australia, additionally set the applicable network service provider and then the grid type.

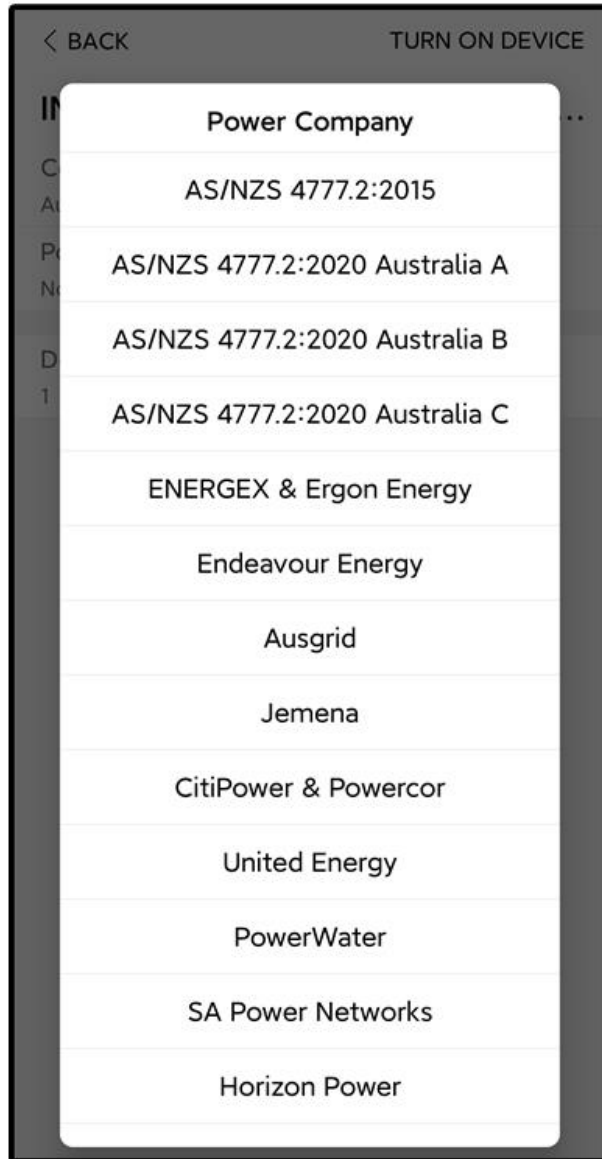

The image shown here is for reference only. Refer to the actual interface for the supported network service providers.

table 7-1 Description of Network Service Provider and Grid Type

Network Service Provider	Grid Type
AS/NZS 4777.2:2015	/
AS/NZS 4777.2:2020	/
Australia A	/
AS/NZS 4777.2:2020	/
Australia B	/

Network Service Provider	Grid Type
AS/NZS 4777.2:2020 Australia C	/
ENERGEX & Ergon Energy	<ul style="list-style-type: none"> • STNW1170: single-phase < 10 kVA & three-phase < 30 kVA • STNW1174: 30 kVA < P_n ≤ 1500 kVA
Jemena	<ul style="list-style-type: none"> • ≤ 10 kVA per phase (or 30 kVA per three phase) • ELE GU 0014: 30 kVA–200 kVA
Endeavour Energy	MDI 0043
Ausgrid	NS194
CitiPower & Powercor	<ul style="list-style-type: none"> • ≤ 5 kVA for single-phase & 30 kVA for three-phase • > 30 kVA three-phase
United Energy	<ul style="list-style-type: none"> • UE-ST-2008.1: ≤ 10 kVA for single-phase & 30 kVA for three-phase • UE-ST-2008.2: > 30 kVA three-phase
PowerWater	Embedded Generation Notice Photovoltaic Systems:2020
SA Power Networks	<ul style="list-style-type: none"> • TS129-2019: < 10 kW for single-phase & 30 kW for three-phase • TS130-2017: > 30 kW & ≤ 200 kW • TS131-2018: > 200 kW
Horizon Power	<ul style="list-style-type: none"> • HPC-9DJ-13-0001-2019: ≤ 10kVA for single-phase & 30 kVA for three-phase • HPC-9DJ-13-0002-2019: > 30kVA & ≤1MVA
westernpower	EDM#33612889-2019
AusNet Services	Basic Micro Embedded Generation: 2020

* For compliance with AS/NZS 4777.2:2020, please select from Australia A/B/C. Please contact your electricity grid operator for which region to use.



- Please check the country supported by this product at [http:// support.sungrow-power.com/](http://support.sungrow-power.com/).
- Set **Country/Region** to the country/region where the inverter is installed. Otherwise, the inverter may report a fault.

step 10 After a plant is successfully created, return to the App home page to view the plant information.

step 11 After the plant has been created, you can choose Settings→Power Control to view or change the settings of power control parameters.

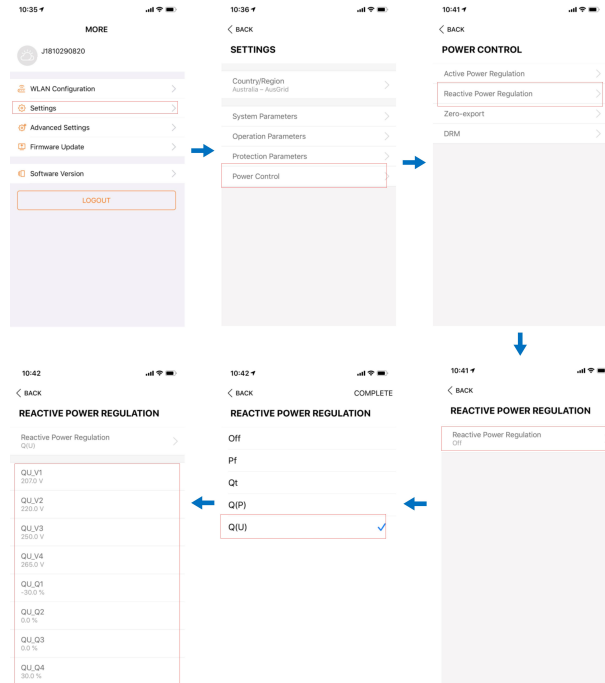

-
- You can also choose Settings→Protection Parameters to view or change the settings of protection threshold voltages.
-
-

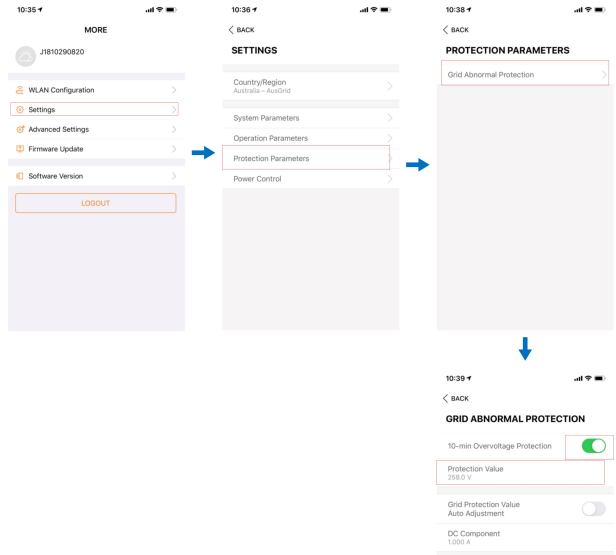

-- End

8 iSolarCloud App

8.1 Brief Introduction

The iSolarCloud App can establish communication connection to the inverter via the WLAN, providing remote monitoring, data logging and near-end maintenance on the inverter. Users can also view inverter information and set parameters through the App.

To achieve direct login via WLAN, the wireless communication module developed and manufactured by SUNGROW is required. The iSolarCloud App can also establish communication connection to the inverter via Ethernet connection.



- This manual describes only how to achieve near-end maintenance via WLAN direct connection.
- Screenshots in this manual are based on the V2.1.6 App for Android system, and the actual interfaces may differ.

8.2 Installing App

Method 1

Download and install the App through the following application stores:

- MyApp (Android, mainland China users)
- Google Play (Android, users other than mainland China ones)
- App Store (iOS)

Method 2

Scan the following QR code to download and install the App according to the prompt information.



The App icon appears on the home screen after installation.



8.3 Account Registration

The account distinguishes two user groups, end user and distributor/installer.

- The end user can view plant information, create plants, set parameters, share plants, etc.
- The distributor/installer can help the end user to create plants, manage, install, or maintain plants, and manage users and organizations.

step 1 Tap **REGISTER** to enter the registration screen.

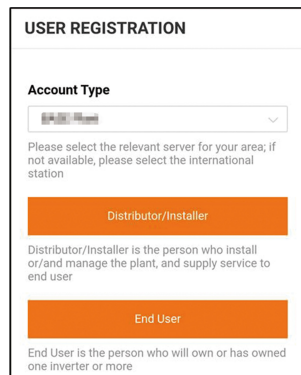

USER REGISTRATION

Account Type

Owner, Retailer

Please select the relevant server for your area; if not available, please select the international station

Distributor/Installer

Distributor/Installer is the person who install or/and manage the plant, and supply service to end user

End User

End User is the person who will own or has owned one inverter or more

step 2 Select the relevant server for your area.

step 3 Select **Owner** or **Retailer/Installer** to enter the corresponding screen.

The screenshot shows a mobile registration form titled "Distributor/Installer". At the top left is a "< BACK" button. The form contains the following fields and elements:

- Contact Phone Number:** A field with a dropdown menu showing "+86" and a "Please Enter" prompt.
- Send Verification Code:** A blue button.
- Verification Code:** A field with a "Please Enter" prompt and a "Help" icon.
- Username:** A field with a "Please Enter" prompt and a help icon.
- Password:** A field with a "Please Enter" prompt.
- Confirm Password:** A field with a "Please Enter" prompt.
- Country/Region:** A dropdown menu with a "Please Select" prompt and a right-pointing arrow.
- Company Name:** A text input field.
- Accept Privacy Policy:** A radio button next to the text "Accept Privacy Policy".
- REGISTER:** A grey button at the bottom.

- step 4 Fill in the registration information, including email, verification code, password and affirmation and country (region). The distributor/installer has the permission to fill in the company name and the code of upper level installer/distributor.



The code of upper level distributor/installer can be obtained from the upper level distributor/installer. Only when your organization belongs to the upper level distributor/installer organization, can you fill in the corresponding code.

- step 5 Tick **Accept Privacy Policy** and tap **Register** to finish the registration operation.

-- End

8.4 Login

8.4.1 Requirements

The following requirements should be met:

- The AC and DC sides or the AC side of the inverter is powered-on.
- The WLAN function of the mobile phone is enabled.
- The mobile phone is within the coverage of the wireless network produced by the communication module.

8.4.2 Login Procedure

- step 1 For the WiNet-S2 module, press the multi-function button 3 times to enable the WLAN hot-spot. No password is required and the valid time is 30 minutes.

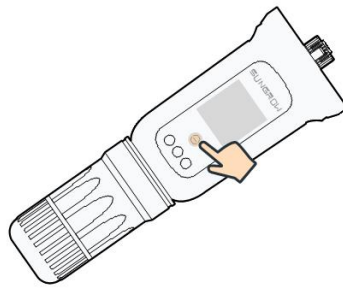

figure 8-1 Enabling the WLAN Hotspot

- step 2 Connect the mobile phone to the WLAN network named as "SG-xxxxxxxxxx" (xxxxxxxxxx is the serial number indicated on the side of the communication module).
- step 3 Open the App to enter the login screen. Tap **Local Access** to enter the next screen.
- step 4 Tap **Confirm**, then enter the password and tap **LOGIN**. Or tap **MANUAL CONNECTION** at the bottom of the interface and select **WiNet-S2**, then enter the password and tap **LOGIN**.



- If the WiFi signal, serial number or inverter related data information cannot be found, unplug and reinsert the WiNet-S2 or press the multi-function button of the WiNet-S2 three times.
- The default account is "user" and the initial password is "pw1111" which should be changed for the consideration of account security. Tap "More" at the lower right corner on home page and choose "Change Password".

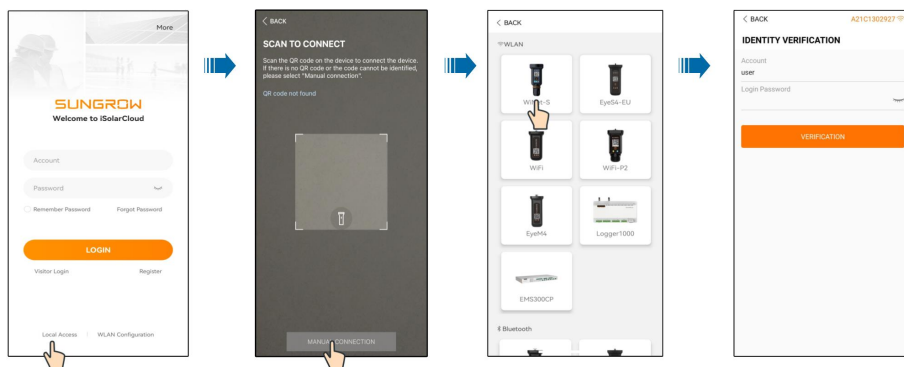

figure 8-2 WLAN Local Access

- step 5 If the inverter is not initialized, navigate to the quick setting screen to initialize the protection parameters. For details, please refer to "**Initial Settings**".

NOTICE

The "Country/Region" must be set to the country where the inverter is installed at. Otherwise, the inverter may report errors.

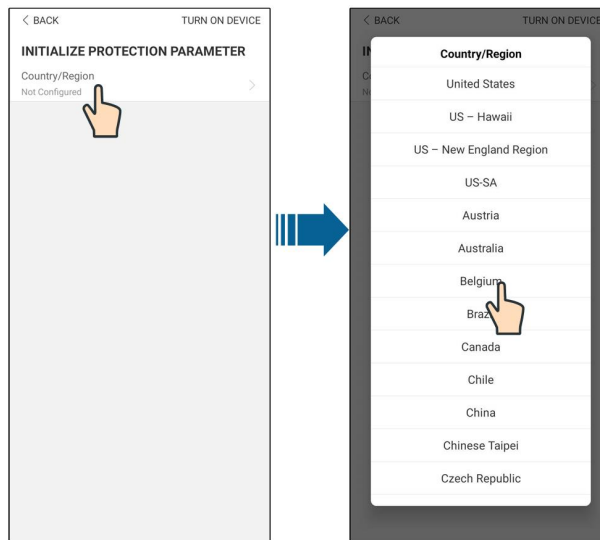

figure 8-3 WLAN Local Access

- step 6 After finishing the settings, tap **TURN ON DEVICE** at the upper right corner and the device will be initialized. The App will send start instructions and the device will start and operate.
- step 7 After initialization settings, the App will return automatically to the home page.

-- End

8.5 Initial Settings

8.5.1 Feed-in Limitation

The function of the feed-in limitation is to control the amount of power injected in the grid by the plant. In some situations, this function is also called as **Export limitation** or **Zero export**. The feed-in limitation function requires the using of Smart Energy Meter. Without the Smart Energy Meter, the feed-in limitation function will be unavailable.

8.5.2 Backup Mode

The backup mode is off by default, the user can set an amount of **Reserved Battery SOC for Off-Grid**. It is the minimum battery level in the on-grid state and will be supplied to the Backup loads in case of grid blackout.

8.5.3 Reactive Power Regulation Mode

The inverter provides a reactive power regulation function. Use the **Reactive Power Regulation Mode** parameter to activate this function and select proper regulation mode.

table 8-1 Descriptions of reactive power regulation mode:

Mode	Descriptions
Off	The PF is fixed at +1.000.
PF	The reactive power can be regulated by the parameter PF (Power Factor).
Qt	The reactive power can be regulated by the parameter Q-Var limits (in %).
Q(P)	The PF changes with the output power of the inverter.
Q(U)	The reactive power changes with the grid voltage.

“Off” Mode

The reactive power regulation function is disabled. The PF is limited to +1.000.

“PF” Mode

The power factor is fixed and reactive power setpoint is calculated according to the current power. The PF ranges from 0.8 leading to 0.8 lagging.

Leading: The inverter supplies reactive power to the grid.

Lagging: The inverter absorbs reactive power from the grid.

“Qt” Mode

In the Qt mode, system rated reactive power is fixed, and the system injects reactive power according to the delivered reactive power ratio. The **Reactive Power Ratio** is set through the App.

The setting range of the reactive power ratio is 0~100% or 0~-100%, corresponding to the ranges of inductive and capacitive reactive power regulation respectively.

“Q(P)” Mode

The PF of the inverter output varies in response to the output power of the inverter.

table 8-2 “Q(P)” Mode Parameter Descriptions:

Parameter	Explanation	Default		Range
		DE	AU	
Q(P) Curve	Select corresponding curve according to local regulations	A		A, B, C*
QP_P1	Output power at P1 on the Q(P) mode curve (in percentage)	20%	25%	0% ~ 100%
QP_P2	Output power at P2 on the Q(P) mode curve (in percentage)	50%		20% ~ 100%
QP_P3	Output power at P3 on the Q(P) mode curve (in percentage)	100%		20% ~ 100%
QP_K1	Power factor at P1 on the Q(P) mode curve	1		Curve A/C: 0.8 ~ 1
QP_K2	Power factor at P2 on the Q(P) mode curve	1		
QP_K3	Power factor at P3 on the Q(P) mode curve	0.95	0.90	Curve B: - 0.6 ~ 0.6

Parameter	Explanation	Default		Range
		DE	AU	
QP_Enter-Voltage	Voltage percentage for Q(P) function activation	105%		100% ~ 110%
QP_ExitVoltage	Voltage percentage for Q(P) function deactivation	100%		90% ~ 100%
QP_ExitPower	Power percentage for Q(P) function deactivation	20%		1% ~ 100%
QP_EnableMode	Unconditional activation/deactivation of Q(P) function	Yes		Yes / No

* Curve C is reserved and consistent with Curve A currently.

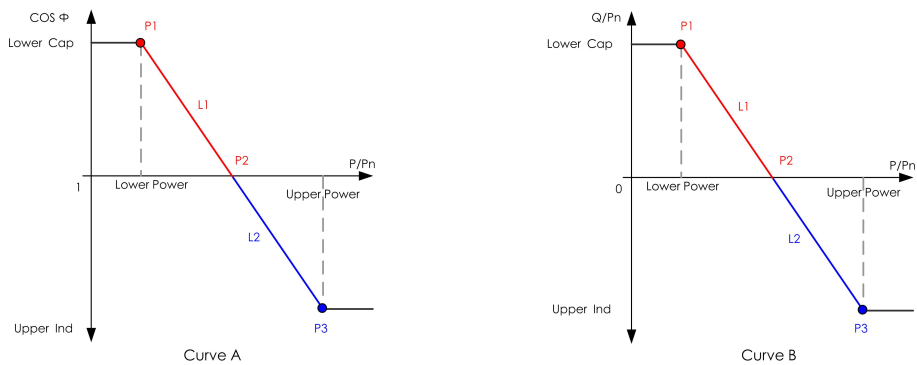

figure 8-4 Q(P) Curve

“Q(U)” Mode

The reactive power output of the inverter will vary in response to the grid voltage.

table 8-3 “Q(U)” Mode Parameter Descriptions:

Parameter	Explanation	Default		Range
		DE	AU	
Q(U) curve	Select corresponding curve according to local regulations		A	A, B, C*
Hysteresis Ratio	Voltage hysteresis ratio on the Q(U) mode curve		0	0 ~ 5%
QU_V1	Grid voltage limit at P1 on the Q(U) mode curve	93%	90%	80% ~ 100%
QU_Q1	Value of Q/Sn at P1 on the Q(U) mode curve	-60%	-30%	-60% ~ 0
QU_V2	Grid voltage limit at P2 on the Q(U) mode curve	97%	95.6%	80% ~ 110%
QU_Q2	Value of Q/Sn at P2 on the Q(U) mode curve		0	-60% ~ 60%
QU_V3	Grid voltage limit at P3 on the Q(U) mode curve	103%	AU: 108.7% NZ: 108.6%	100% ~ 120%

Parameter	Explanation	Default		Range
		DE	AU	
QU_Q3	Value of Q/Sn at P3 on the Q(U) mode curve		0	-60% ~ 60%
QU_V4	Grid voltage limit at P4 on the Q(U) mode curve	107%	AU: 115.2% NZ: 110.8%	100% ~ 120%
QU_Q4	Value of Q/Sn at P4 on the Q(U) mode curve	60%	30%	0 ~ 60%
QU_EnterPower	Active power for Q(U) function activation		80%	20% ~ 100%
QU_ExitPower	Active power for Q(U) function deactivation		10%	1% ~ 20%
QU_EnableMode	Unconditional activation/deactivation of Q(U) function		Yes	Yes / No / Yes, Limited by PF

* Curve C is reserved and consistent with Curve A currently.

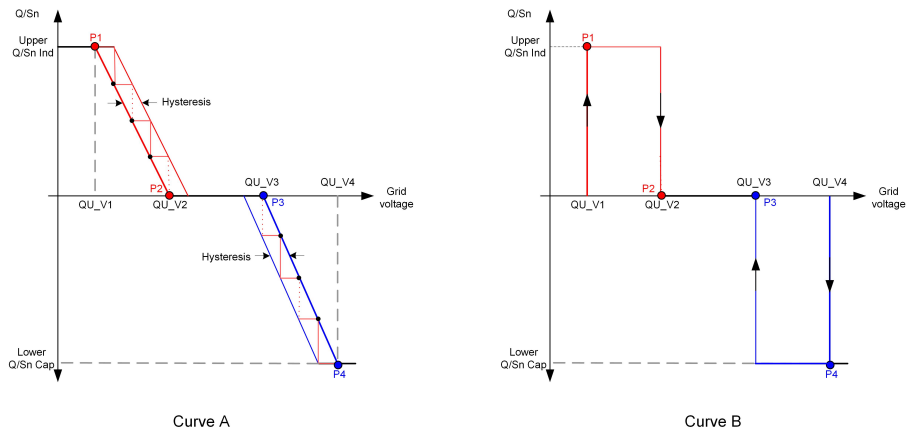

figure 8-5 Q(U) Curve



There is no need to set initialization parameters of the EV charger because it can operate automatically after being identified by iSolarCloud App.

8.6 Function Overview

The App provides parameter viewing and setting functions, as shown in the following figure.

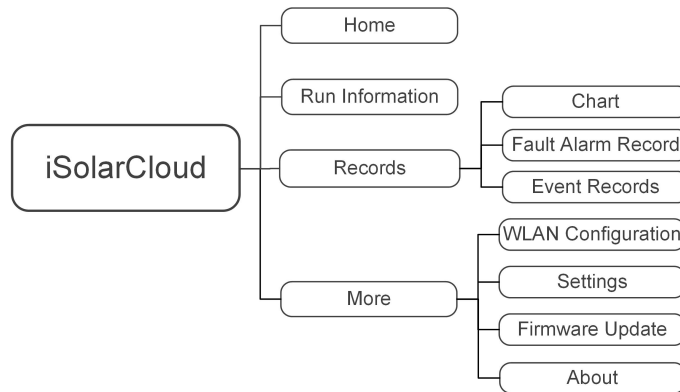

figure 8-6 App Function Tree Map

8.7 Home

Home page of the App is shown in the following figure.

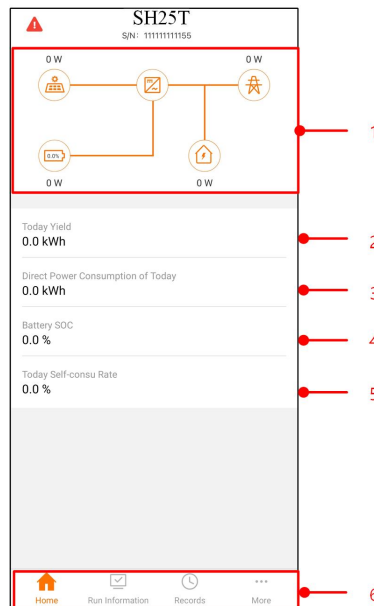



figure 8-7 Home

table 8-4 Home page description

No.	Name	Description
1	Load flow chart	Shows the PV power generation power, feed-in power, etc. The line with an arrow indicates energy flow between connected devices, and the arrow pointing indicates energy flow direction.
2	Yield Today	Shows today power generation of the inverter

No.	Name	Description
3	Direct Power Consumption of Today	Shows electricity directly consumed by loads today
4	Battery SOC	Indicates remaining battery capacity
5	Today Self-consumption Rate	Indicates today self-consumption rate of the PV system
6	Navigation bar	Includes menus of Home, Run Information, Records, and More.

If the inverter runs abnormally, the fault icon  appears on the upper left corner of the screen. Users can tap the icon to view detailed fault information and corrective measures.

8.8 Run Information

Tap **Run Information** on the navigation bar to enter the corresponding screen, as shown in the following figure.

RUN INFORMATION	
PV Information ^	
String 1 Voltage	0.0 V
String 1 Current	0.00 A
String 2 Voltage	0.0 V
String 2 Current	0.00 A
Daily PV Yield	0.0 kWh
Total PV Yield	0.0 kWh
Inverter Information ^	
Running Status	Shut Down
Bus Voltage	0.0 V
Internal Air Temperature	24.9 °C
Array Insulation Resistance	0 kΩ
Country (Region) Information	Germany
Ripple Control state	No RIPP Schedule
Power Limitation Mode	Unlimited Power

figure 8-8 Run Information

The run information includes the PV information, inverter information, input, output, grid information, load information, and battery information.

8.9 Records

Tap **Records** on the navigation bar to enter the screen, as shown in the following figure.

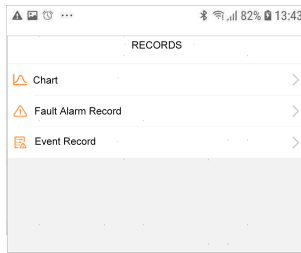

figure 8-9 Records

On **Records** screen, users can view chart and check fault alarm record.

8.9.1 Chart

Tap **Chart** to enter the screen showing daily power generation, as shown in the following figure.

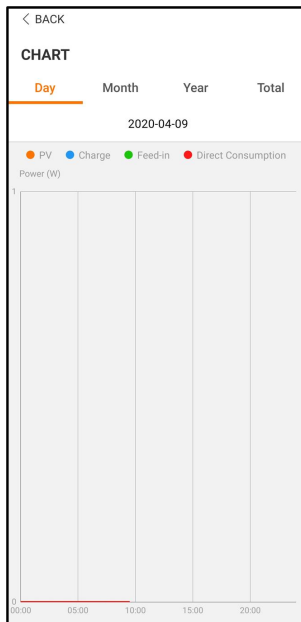

figure 8-10 Power Curve

The App displays power generation records in a variety of forms, including daily power generation graph, monthly power generation histogram, annual power generation histogram, and total power generation histogram.

table 8-5 Description of power generation records

Item	Description
Daily power generation graph	Indicates today power generation, charging, feed-in power, and direct consumption power
Monthly power generation histogram	Indicates monthly power generation, charging, feed-in power, and direct consumption power

Item	Description
Annual power generation histogram	Indicates annual power generation, charging, feed-in power, and direct consumption power
Total power generation histogram	Indicates total power generation, charging, feed-in power, and direct consumption power

8.9.2 Fault Alarm Record

Tap **Fault Alarm Record** to enter the screen, as shown in the following figure.

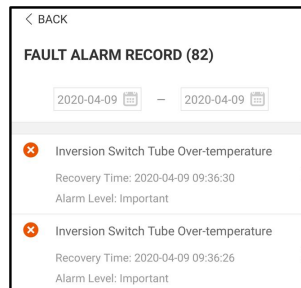

figure 8-11 Fault Alarm Record



Click "📅" to select a time segment and view corresponding records.

Select one of the records in the list and click the record, to view the detailed fault info as shown in following figure.

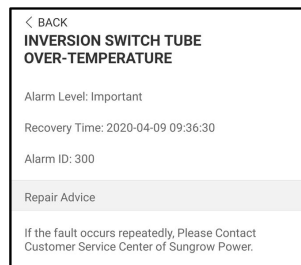

figure 8-12 Detailed fault alarm info

8.9.3 Event Records

Tap **Event Records** to enter the screen, as shown in the following figure.

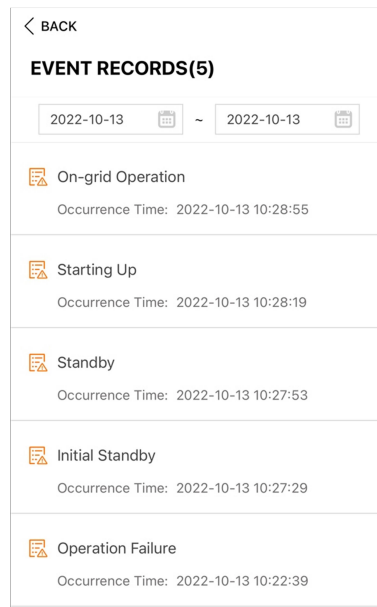

figure 8-13 Event Records

8.10 More

Tap **More** on the navigation bar to enter the screen, as shown in the following figure.

The **More** screen supports the following operations:

- Set parameters including inverter system parameters and energy management parameter.
- Upgrade inverter firmware of the communication module.

8.10.1 System Parameters

Tap **Settings**→**System Parameters** to enter the corresponding interface, as shown in the following figure.

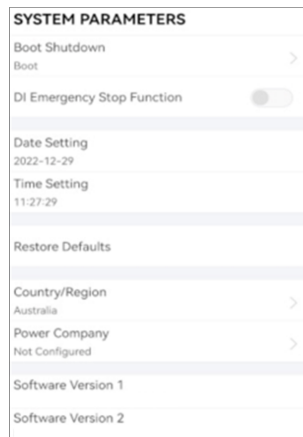

figure 8-14 System Parameters

* The image shown here is for reference only.

Boot/Shutdown

Tap **Boot/Shutdown** to send the boot/shutdown instruction to the inverter.

For Australia and New Zealand, when the DRM state is DRM0, the "Boot" option will be prohibited.

Date Setting/Time Setting

The correct system time is very important. Wrong system time will directly affect the data logging and power generation value. The clock is in 24-hour format.

Country or Region/Power Company

Here you can view the settings of country/region and power company.

Software Version

Version information of the current firmware.

8.10.2 Running Time

Tap **Settings**→**Operation Parameters**→**Running Time** to enter the corresponding screen, on which you can set **Connecting Time** and **Reconnecting Time**.

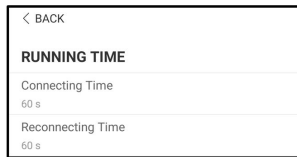

figure 8-15 Running Time

table 8-6 Description of running time parameters

Parameter	Explanation	Default	Range
Connecting Time	The time that the inverter takes to enter into the running mode from the standby mode in fault-free state	60s	10s ~ 900s
Reconnecting Time	The time that the inverter takes to recover from the fault state to normal state (the inverter is not running)	60s	0s ~ 3600s

8.10.3 Fault Recovery

Tap **Settings**→**Operation Parameters**→**Fault Recovery** to enter the corresponding screen, on which you can see the fault recovery records.

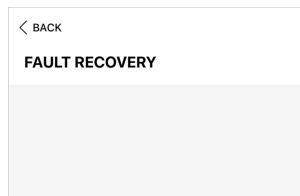

figure 8-16 Fault Recovery

8.10.4 Regular Parameters

Tap **Settings**→**Operation Parameters**→**Regular Parameters** to enter the screen, as shown in the following figure.

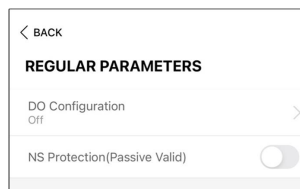

figure 8-17 Regular Parameters

After connecting the load to the DO terminals, a relay control signal will be transmitted. Users can flexibly set the control mode of DO configuration according to individual demand. NS protection is enabled, and the inverter stops in an emergency.

table 8-7 The control mode of DO configuration

Mode	Setting description
Off	-
Load Control Mode	See "8.10.10 Load Control"
Grounding Detection	See "8.10.13 Grounding Detection"

8.10.5 Off-grid Parameters

Tap **Settings**→**Operation Parameters**→**Off-grid Parameters** to enter the screen, as shown in the following figure.

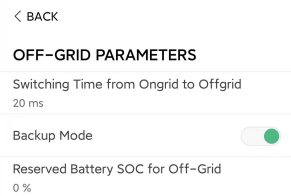

figure 8-18 Off-grid Parameters

Refer to the description in "[8.5.2 Backup Mode](#)".

8.10.6 Active Power Regulation

Tap **Settings**→**Power Regulation Parameters**→**Active Power Regulation** to enter the screen, as shown in the following figure.

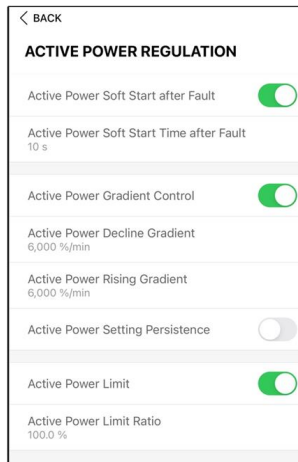

figure 8-19 Active Power Regulation

table 8-8 Description of active power regulation

Parameter	Description	Default	Range
Active Power Soft Start after Fault	Switch for activating/deactivating the function of active power soft start after a fault occurs	On	On/Off
Active Power Soft Start Time after Fault	The soft start time required for raising active power from 0 to rated value after a fault occurs	600s	1s ~ 1200s
Active Power Gradient Control	Set whether to enable active power gradient control	On	On/Off
Active Power Decline Gradient	Decline gradient of inverter active power per minute	39%/min	1%/min ~ 6000%/min
Active Power Rising Gradient	Rising gradient of inverter active power per minute		
Active Power Setting Persistence	Switch for activating/deactivating the function of active power setting persistence	Off	On/Off
Active Power Limit	Switch for limiting active power	On	On/Off
Active Power Limit Ratio	The ratio of active power limit to rated power in percentage	100.0%	0 ~ 100%

8.10.7 Reactive Power Regulation

Tap **Settings**→**Power Regulation Parameters**→**Reactive Power Regulation** to enter the screen, as shown in the following figure.

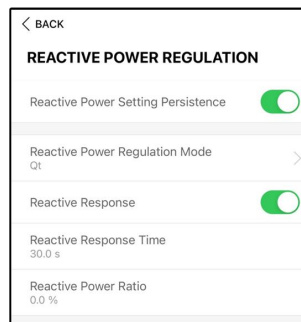

figure 8-20 Reactive Power Regulation

table 8-9 Description of reactive power regulation

Parameter	Description	Default	Range
Reactive Power Setting Persistence	Switch for activating/deactivating the function of reactive power setting persistence	On	On / Off
Reactive Power Regulation Mode	See " 8.5.3 Reactive Power Regulation Mode "	Off	Off / PF / Qt / Q(P) / Q(U)
Reactive Response	Reactive response function on and off	On	On / Off
Reactive Response Time	Reactive power response time	30.0s	0.1s — 600s
Reactive Power Ratio	Ratio of reactive power	0.0%	0.0% — 100%

8.10.8 Battery Discharge Time

Tap **Settings**→**Energy Management Parameters**→**Battery Discharge Time** to enter the corresponding screen, as shown in the following figure.

These are the times of day at which the battery is allowed to discharge to the house loads.

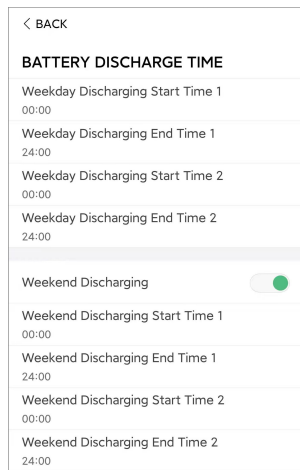

figure 8-21 Battery Discharge Time

8.10.9 Battery Forced Charge Time

Tap **Settings**→**Energy Management Parameters**→**Battery Forced Charge Time** to enter the corresponding screen.

These are the times of day at which the inverter will start charging the battery with rated AC power.

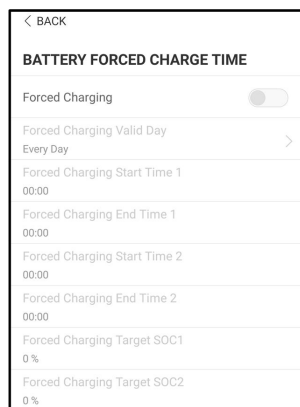

figure 8-22 Battery Forced Charge Time

When there is no PV power, the power imported from the grid charges the energy system during the time period until the target SOC is reached.

It is recommended to set the time period in off-peak tariff time. The time period 1 is in priority to the time period 2 if two periods overlap. The charging energy comes from the excess PV energy in priority and then from the grid. The inverter will take charging power from the grid in the case of PV energy shortage.

8.10.10 Load Control

Tap **Settings**→**Energy Management Parameters**→**Load Control** to enter the corresponding screen, on which you can set **Load Control Mode**. Load Control Mode includes **Timing Mode**, **Switch Mode**, and **Intelligent Mode**.

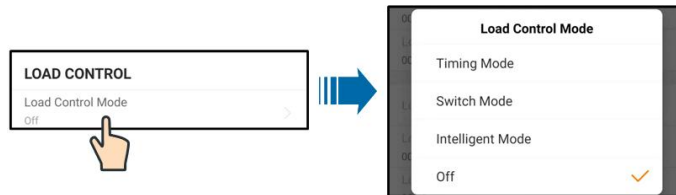

figure 8-23 Load Control

Timing Mode

In this mode, set the **Load Timing Start Time 1** and **Load Timing End Time 1**, the system will control the load operation during the interval. Take 09:00 am–09:30 am as an example.

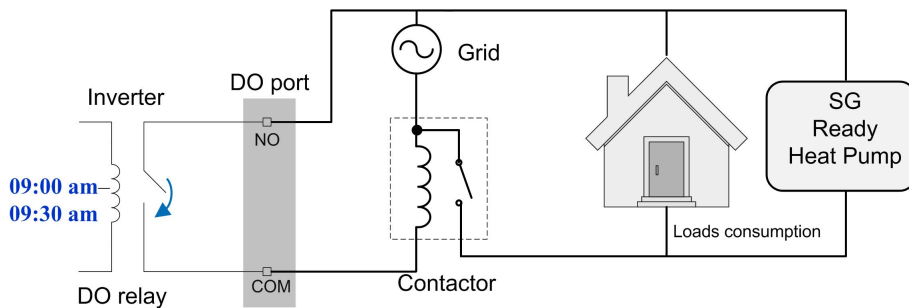

figure 8-24 DO Operation in Timing Mode

Switch Mode

In this mode, the system will control the load operation according to the setting. In the following example, the switch is set to OFF.

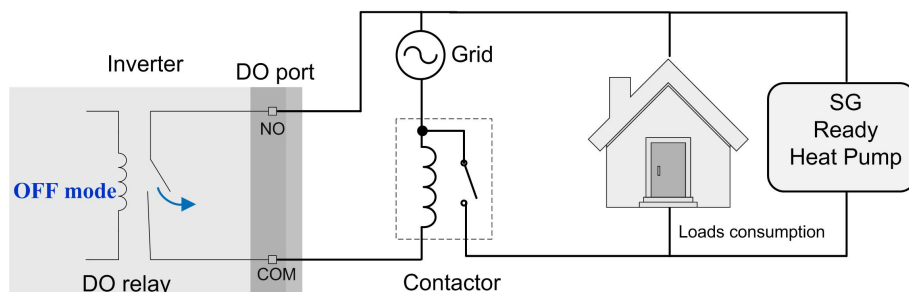

figure 8-25 DO Operation in Switch Mode

Intelligent Mode

The system will control the load operation according to the power optimization algorithm of energy management.

During the setting interval, the DO function will be enabled to power on the load if the excess PV energy exceeds the optimized power value.

Notice:

The intelligent mode is disabled in an off-grid system.

- When the inverter is installed to retrofit an existing PV system, the upper limit of optimized power is the sum of the rated power of the hybrid inverter and the rated power of the existing PV inverter.
- Once the intelligent mode is enabled, the DO relay will remain connected for 20 minutes after the DO connection.

Take 09:00 am–09:30 am and the optimized power of 1000 W as an example.

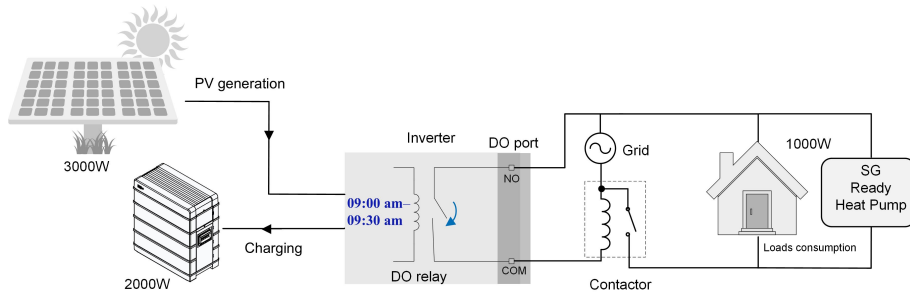

figure 8-26 DO Operation in Intelligent Mode

8.10.11 Communication Parameters

Tap **Settings**→**Communication Parameters** to enter the screen, as shown in the following figure.

- The device address ranges from 1 to 246.
- The IP address, gateway, subnet mask, preferred DNS server and alternate DNS server can be modified only when the DHCP is set to Off.
- Acquire the IP address, gateway, subnet mask, preferred DNS server and alternate DNS server from the network professional.

8.10.12 Firmware Update

To avoid download failure due to poor on-site network signal, it is recommended to download the firmware package to the mobile device in advance.

step 1 Enable the "Mobile data" of the mobile device.

step 2 Open the App, enter the account and password on the login screen. Tap **Login** to enter the home screen.

step 3 Tap **More**→**Firmware Download** to enter corresponding screen on which you can view the device list.

step 4 Select the device model before downloading the firmware. Tap the device name in the device list to enter the firmware upgrade package detail interface, and tap  behind the firmware upgrade package to download it.

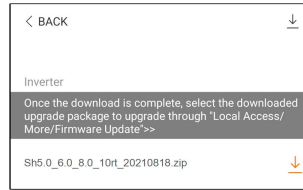

step 5 Return to the **Firmware Download** screen, tap  in the upper right corner of the screen to view the downloaded firmware upgrade package.

step 6 Login the App via local access mode. Refer to "[8.4 Login](#)".

step 7 Tap **More** on the App home screen and then tap **Firmware Update**.

step 8 Tap the upgrade package file, a prompt box will pop up asking you to upgrade the firmware with the file, tap **CONFIRM** to perform the firmware upgrade.



step 9 Wait for the file to be uploaded. When the upgrade is finished, the interface will inform you of the upgrade completion. Tap **Complete** to end the upgrade.

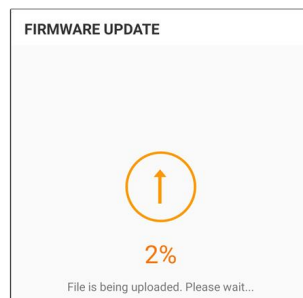

NOTICE

- **Inverter or battery firmware update must be performed when the system is running in the grid-connected state; otherwise, the backup loads may see a power failure or the update may fail.**
- **Do not take other actions, such as setting parameters, during the process of inverter firmware update, to avoid update failure.**

-- End

8.10.13 Grounding Detection



Contact your distributor to obtain the advanced account and corresponding password before setting the earth detection parameters. If the distributor is unable to provide the required information, contact SUNGROW.

Unauthorized personnel are not allowed to log in with this account. Otherwise, SUNGROW shall not be held liable for any damages caused.

Tap **More**→**Settings**→**Operation Parameters**→**Grounding Detection** to enter the corresponding screen.



figure 8-27 Grounding Detection

If the grounding detection is enabled, the DO relay will switch on automatically to signal the external alarm if the value exceeds the grounding detection alarm value. The buzzer inside the inverter will beep.

The PV insulation resistance fault (fault sub-code 039) will trigger the DO relay to signal the external alarm.

8.10.14 Parallel Configuration

When two inverters are connected in parallel, the inverter needs to be set as the master or slave.

Tap **More**→**Settings**→**Power Regulation Parameters**→**Feed-in Limitation** to enter the corresponding screen.

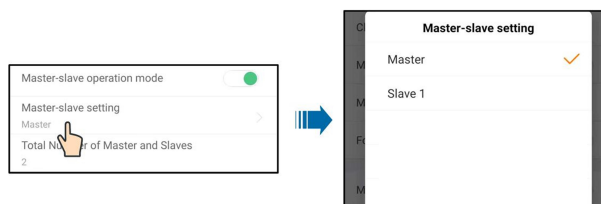

Parameter	Default value	Range
Master-slave operation mode	ON	ON / OFF
Master-slave setting	Master	Master / Slave 1
Total Number of Master and Slaves	2	2

8.10.15 Frequency Shift Power Control

Tap **More**→**Settings**→**Operation Parameters**→**Other Parameters** to enter the corresponding screen.



Parameter	Default value	Range
Frequency Shift Power Control	OFF	ON / OFF
Frequency Shift Test	OFF	ON / OFF
Set Test Frequency	50.00 Hz	50.00 ~ 55.00 Hz

If PV inverters are connected on the AC side during battery-backup operation, the hybrid inverter must be able to limit their output power. This limitation becomes necessary when, for example, the hybrid inverter's battery is fully charged and the power available from the PV system exceeds the power requirement of the connected loads.

To prevent excess energy from overcharging the battery, the hybrid inverter automatically detects the problem and changes the frequency at the AC output. This frequency adjustment is analyzed by the PV inverter. As soon as the power frequency of the battery-backup grid increases beyond the value specified in **Set Test Frequency**, the PV inverter limits its output power accordingly.

Before retrofitting the existing PV system to an off-grid port, the **Frequency Shift Power Control** parameter needs to be enabled. It must be ensured that the connected PV inverters limit their power at the AC output via the hybrid inverter due to changes in frequency. The frequency-dependent active power limitation PF must be set in the PV inverter.



When the battery SOC is greater than 85%, the Hybrid inverter will standby before starting when switching off-grid, and does not support seamless switching.

8.10.16 Import Power Limit

1. To avoid damage to the inverter due to excessive power import from the grid, set the "Import Power Limit" for the inverter immediately after completing the wiring.
2. This parameter can only be set by an Installer account.

Tap **More**→**Settings**→**Operation Parameters**→**Other Parameters** to enter the corresponding screen.

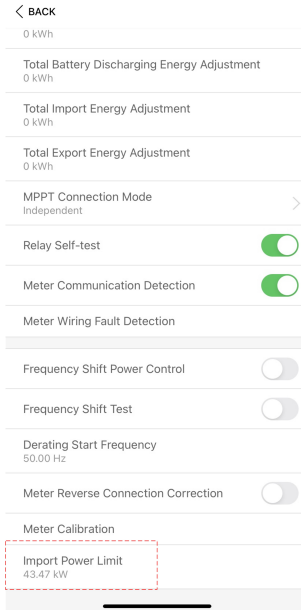

Parameter	Default value	Range
Import Power Limit	43.47kW	0-50kW

The formula used to calculate the import power limit should be: Set value of Import Power Limit (kW) $\leq 3 \times 230 \times 0.8 \times$ rated current of the house's main switch.

8.10.17 Energy Management Mode

Tap **Settings**→**Energy Management Parameters**→**General Parameters**→**Energy Management Mode** to enter the screen, as shown in the following figure.

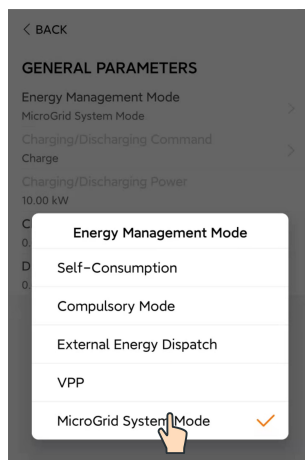

figure 8-28 Energy Management Mode

Parameter	Description
Self-Consumption Mode	The normal operation mode of the inverter, where the inverter will cover the house load with PV and battery power. if the PV is higher than the load and the battery is full, the power will be injected in the grid according to the Feed-in Limitation settings.
Compulsory Mode	The Force Charge or Force Discharge of the battery. Set the Force Charge or Discharge power and the battery will charge/discharge to the house load or the grid.
External Energy Dispatch	The inverter is controlled by an external energy management system through Modbus RTU or TCP.

8.10.18 DO Configuration

Tap **Settings**→**Operation Parameters**→**Regular Parameters**→**DO Configuration** to enter the screen, as shown in the following figure.

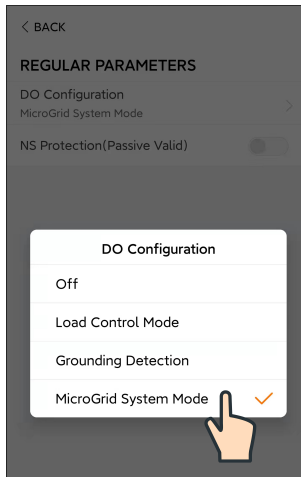

figure 8-29 DO Configuration

9 System Decommissioning/Shutdown Procedure

9.1 Decommissioning the Inverter

9.1.1 Disconnect the Inverter

⚠ CAUTION

Danger of burns!

Even if the inverter is shut down, it may still be hot and cause burns. Wear protective gloves before operating the inverter after it cools down.

For maintenance or other service work, the inverter must be switched off.

Proceed as follows to disconnect the inverter from the AC and DC power sources. Lethal voltages or damage to the inverter will follow if otherwise.

- step 1 Disconnect the external AC circuit breaker and prevent it from inadvertent reconnection.
- step 2 Rotate the DC switch to the "OFF" position for disconnecting all of the PV string inputs.
- step 3 Wait about minutes until the capacitors inside the inverter completely discharge.
- step 4 Ensure that the DC cable is current-free with a current clamp.

-- End

9.1.2 Dismantling the Inverter

⚠ CAUTION

Risk of burn injuries and electric shock!

After the inverter is powered off for 10 minutes, measure the voltage and current with professional instrument. Only when there is no voltage nor current can operators who wear protective equipment operate and maintain the inverter.

Before dismantling the inverter, disconnect both AC and DC connections.

If there are more than two layers of inverter DC terminals, dismantle the outer DC connectors before dismantling the inner ones.



If the original packing materials are available, put the inverter inside them and then seal them using adhesive tape. If the original packing materials are not available, put the inverter inside a cardboard box suitable for the weight and size of this inverter and seal it properly.

- step 1 Refer to "[6 Electrical Connection](#)" for the inverter disconnection of all cables in reverse steps.
- step 2 Dismantle the inverter referring to "[5 Mechanical Mounting](#)" in reverse steps.
- step 3 If necessary, remove the wall-mounting bracket from the wall.
- step 4 If the inverter will be reinstalled in the future, please refer to "[4.3 Inverter Storage](#)" for a proper conservation.

-- End

9.1.3 Disposal of Inverter

Users take the responsibility for the disposal of the inverter.

WARNING

Please scrap the inverter in accordance with relevant local regulations and standards to avoid property losses or casualties.

NOTICE

Some parts of the inverter may cause environmental pollution. Please dispose of them in accordance with the disposal regulations for electronic waste applicable at the installation site.

9.2 Decommissioning the Battery

Decommission the battery in the system after the inverter is decommissioned. Proceed as follows to decommission a Li-ion battery.

- step 1 Disconnect the DC circuit breaker between the battery and the inverter.
- step 2 Disconnect the communication cable between the battery and the inverter.
- step 3 Wait for about 1 minute and then use the multimeter to measure the port voltage of the battery.
- step 4 If the battery port voltage is zero, disconnect the power cables from the battery module.

-- End



For disposal of this product, please call the phone number listed in the warranty booklet provided at the time of purchase.

10 Troubleshooting and Maintenance

10.1 Troubleshooting



Please refer to the charger user manual for the fault code of the charger.

When an alarm occurs, the alarm information can be viewed through the App.

Alarm ID and corrective measures are as follows:

Alarm ID	Alarm Name	Corrective Measures
002, 003, 014, 015	Grid Overvoltage	<p>Generally, the inverter will be reconnected to the grid after the grid returns to normal. If the fault occurs repeatedly:</p> <ol style="list-style-type: none">1. Measure the actual grid voltage, and contact the local electric power company for solutions if the grid voltage is higher than the set value.2. Check whether the protection parameters are appropriately set via the App or the LCD. Modify the overvoltage protection values with the consent of the local electric power operator.3. If the fault still exists, contact SUNGROW.
004, 005	Grid Undervoltage	<p>Generally, the inverter will be reconnected to the grid after the grid recovers. If the alarm occurs frequently:</p> <ol style="list-style-type: none">1. Measure the grid voltage, and contact the local utility grid company for solutions if the grid voltage is below the specified value.2. Check, through the App, whether the protection parameters are appropriately set.3. Check whether the AC cable is firmly in place.4. If the alarm persists, contact SUNGROW.

Alarm ID	Alarm Name	Corrective Measures
008	Grid Overfrequency	<p>Generally, the inverter will be reconnected to the grid after the grid recovers. If the alarm occurs frequently:</p> <ol style="list-style-type: none"> 1. Measure the grid frequency, and contact the local utility grid company for solutions if the grid frequency is beyond the specified range.
009	Grid Underfrequency	<ol style="list-style-type: none"> 2. Check, through the App, whether the protection parameters are appropriately set. 3. If the alarm persists, contact SUNGROW.
010	Grid Power Outage	<p>Generally, the inverter will be reconnected to the grid after the grid recovers. If the alarm occurs frequently:</p> <ol style="list-style-type: none"> 1. Check whether the grid supplies power reliably. 2. Check whether the AC cable is firmly in place. 3. Check whether the AC cable is correctly connected (whether the live wire and the N wire are in correct place). 4. Check whether the AC switch or circuit breaker is disconnected. 5. If the alarm persists, contact SUNGROW.
012	Excessive Leakage Current	<ol style="list-style-type: none"> 1. The alarm can be caused by poor sunlight or damp environment, and the inverter will be reconnected to the grid after the environment is improved. 2. If the environment is normal, check whether the AC and DC cables are well insulated. 3. If the alarm persists, contact SUNGROW.
013	Grid Abnormal	<p>Generally, the inverter will be reconnected to the grid after the grid recovers. If the alarm occurs frequently:</p> <ol style="list-style-type: none"> 1. Measure the grid frequency, and contact the local utility grid company for solutions if the grid frequency exceeds the specified value. 2. If the alarm persists, contact SUNGROW.

Alarm ID	Alarm Name	Corrective Measures
017	Grid Voltage Unbalance	<p>Generally, the inverter will be reconnected to the grid after the grid returns to normal. If the fault occurs repeatedly:</p> <ol style="list-style-type: none"> 1. Measure the actual grid voltage. If grid phase voltages differ greatly, contact the electric power company for solutions. 2. If the voltage difference between phases is within the permissible range of the local power company, modify the grid voltage imbalance parameter through the App. 3. If the fault still exists, contact SUNGROW.
028, 029	PV Reverse Connection Fault	<ol style="list-style-type: none"> 1. Check whether the corresponding string is of reverse polarity. If so, disconnect the DC switch and adjust the polarity when the string current drops below 0.5 A. 2. If the fault still exists, contact SUNGROW. <p>*The code 28 to code 29 are corresponding to PV1 to PV2 respectively.</p>
037	High Ambient Temperature	<p>Generally, the inverter will resume operation when the internal or module temperature returns to normal. If the fault persists:</p> <ol style="list-style-type: none"> 1. Check whether the ambient temperature of the inverter is too high; 2. Check whether the inverter is in a well-ventilated place; 3. Check whether the inverter is exposed to direct sunlight. Shield it if so; 4. Check whether the fan is running properly. Replace the fan if not; 5. If the fault still exists, contact SUNGROW.

Alarm ID	Alarm Name	Corrective Measures
039	Low System Insulation Resistance	<p>Wait for the inverter to return to normal. If the fault occurs repeatedly:</p> <ol style="list-style-type: none"> 1. Check whether the ISO resistance protection value is excessively high via the app, and ensure that it complies with the local regulations. 2. Check the resistance to ground of the string and DC cable. Take corrective measures in case of short circuit or damaged insulation layer. 3. If the cable is normal and the fault occurs on rainy days, check it again when the weather turns fine. 4. If there are batteries, check whether battery cables are damaged and whether terminals are loose or in poor contact. If so, replace the damaged cable and secure terminals to ensure a reliable connection. 5. If the fault still exists, contact SUNGROW.
106	Grounding Cable Fault	<ol style="list-style-type: none"> 1. Check whether the AC cable is correctly connected. 2. Check whether the insulation between the ground cable and the live wire is normal. 3. If the fault still exists, contact SUNGROW.
051	Off-grid Load Overpower	<ol style="list-style-type: none"> 1. Reduce the power of loads connected at the off-grid port, or remove some loads. 2. If the alarm persists, contact SUNGROW.
714	BMS Communication Fault	<ol style="list-style-type: none"> 1. Check whether the communication cable and the terminals are abnormal. If so, correct them to ensure reliable connection. 2. Reconnect the communication cable of the meter. 3. If the fault still exists, contact SUNGROW.
932–935, 937, 939	Battery Alarm	<p>Generally, the battery can automatically recover. In case the alarm persist for a long time:</p> <ol style="list-style-type: none"> 1. If the alarm is caused by ambient temperature, such as over temperature alarm or low temperature alarm, take measures to change the ambient temperature, such as improving heat dissipation conditions. 2. If the fault persists, contact battery manufacturer.

Alarm ID	Alarm Name	Corrective Measures
703, 711, 712, 715, 732–736, 739, 832– 833, 835– 837	Battery Abnormal	<ol style="list-style-type: none"> 1. In case of abnormal battery voltage, check whether the battery power cable connection is abnormal (reverse connection, loose, etc.). If so, connect the battery power cable correctly. 2. Check whether the battery real-time voltage is abnormal if the battery power cable is correctly connected. If so, contact the battery manufacturer. If not, contact SUNGROW. 3. In case of abnormal battery temperature, take measures to change the ambient temperature, such as improving heat dissipation conditions. 4. If the fault persists, contact battery manufacturer.
502-504, 507, 508, 510, 513, 516–518	System Alarm	<ol style="list-style-type: none"> 1. The inverter can continue running. 2. Check whether the related wiring and terminal are abnormal, check whether there are any foreign materials or other environmental abnormalities, and take corresponding corrective measures when necessary. 3. If the alarm persists, please contact SUNGROW.
006, 007, 011, 019 , 021 , 025, 038, 040– 042, 048– 050, 052– 054, 056 , 064–067, 100–102, 105, 107, 113, 117, 200–205, 300 , 303– 305, 308– 316 , 320, 600 , 601, 605, 608, 612, 616, 620, 624	System Fault	<ol style="list-style-type: none"> 1. Wait for the inverter to return to normal. 2. Disconnect the AC and DC switches, and disconnect the battery side switches if there are batteries. Close the AC and DC switches in turn 15 minutes later and restart the system. 3. If the fault still exists, contact SUNGROW.



Contact the distributor if the measures listed in the “Troubleshooting Method” column have been taken but the problem persists. Contact SUNGROW if the distributor fails to solve the problem.

10.2 Maintenance

10.2.1 Maintenance Notices

The DC switch can be secured with a lock in the OFF position or a certain angle beyond the OFF position.(For countries “AU” and “NZ”)

DANGER

Risk of inverter damage or personal injury due to incorrect service!

- **Be sure to use special insulation tools when perform high-voltage operations.**
- **Before any service work, first disconnect the grid-side AC circuit breaker and check the inverter status. If the inverter indicator is off, please wait until night to disconnect the DC switch. If the inverter indicator is on, directly disconnect the DC switch.**
- **After the inverter is powered off for 10 minutes, measure the voltage and current with professional instrument. Only when there is no voltage nor current can operators who wear protective equipment operate and maintain the inverter**
- **Even if the inverter is shut down, it may still be hot and cause burns. Wear protective gloves before operating the inverter after it cools down.**
- **When maintaining the product, it is strictly prohibited to open the product if there is an odor or smoke or if the product appearance is abnormal. If there is no odor, smoke, or obvious abnormal appearance, repair or restart the inverter according to the alarm corrective measures. Avoid standing directly in front of the inverter during maintenance.**

CAUTION

To prevent misuse or accidents caused by unrelated personnel: Post prominent warning signs or demarcate safety warning areas around the inverter to prevent accidents caused by misuse.

NOTICE

Restart the inverter only after removing the fault that impairs safety performance. As the inverter contains no component parts that can be maintained, never open the enclosure, or replace any internal components.

To avoid the risk of electric shock, do not perform any other maintenance operations beyond those described in this manual. If necessary, contact your distributor first. If the problem persists, contact SUNGROW. Otherwise, the losses caused is not covered by the warranty.

NOTICE

Touching the PCB or other static sensitive components may cause damage to the device.

- **Do not touch the circuit board unnecessarily.**
- **Observe the regulations to protect against electrostatic and wear an anti-static wrist strap.**

10.2.2 Routine Maintenance

Item	Method	Period
Device clean	Check the temperature and dust of the inverter. Clean the inverter enclosure if necessary.	Six months to a year (depending on the dust contents in air)
Electrical connection	Check whether all cable are firmly connected in place. Check whether there is damage to the cables, especially the surface in contact with metal.	6 months after commissioning and then once or twice a year
General status of the system	<ul style="list-style-type: none"> • Visual check for any damage or deformation of the inverter. • Check any abnormal noise during the operation. • Check each operation parameter. • Be sure that nothing covers the heat sink of the inverter. 	Every 6 months

10.2.3 Replacing the Button Cell

⚠ DANGER

Disconnect the inverter from the grid first, then the PV strings and the battery before any maintenance work.

Lethal voltage still exists in the inverter. Please wait at least 10 minutes and then perform maintenance work.

There is a button cell on the inner PCB board. Contact SUNGROW for replacement when the relevant fault alarm occurs.

Check the fastener, appearance, voltage, and resistance quarterly and annually.

11 Appendix

11.1 Technical Data

Parameters	SH5T	SH6T
Input (DC)		
Recommended max. PV input power	10000 Wp	12000 Wp
Max. PV input voltage*	1000 V	
Min. PV input voltage / Start-up input voltage	150 V / 180 V	
Rated PV input voltage	600 V	
MPPT operating voltage range	150 V - 950 V	
MPP voltage range for rated power	225 V - 850 V	270 V - 850 V
No. of independent MPP trackers	2	
No. of PV strings per MPPT	1 / 1	
Max. PV input current	32 A (16 A / 16 A)	
Max. DC short-circuit current	40 A (20 A / 20 A)	
Max. current for input connector	30 A	
Battery Data		
Battery type	Li-ion battery	
Battery voltage	100 V - 700 V	
Max. charge / discharge current**	50 A / 50 A	
Max. charge / discharge power	15000 W / 5000 W	15000 W / 6000 W
Input and Output (AC)		
Max. AC power from grid	43000 VA	
Rated AC output power	5000 W	6000 W
Max. AC output apparent power	5000 VA	6000 VA
Max. AC output current	7.6 A	9.1 A
Rated AC voltage	3 / N / PE, 220 / 380 V; 230 / 400 V; 240 / 415 V	

Parameters	SH5T	SH6T
AC voltage range	270 - 480 V	
Rated grid frequency	50 / 60Hz	
Grid frequency range	45 - 55Hz / 55 - 65Hz	
Harmonic (THD)	<3% (of rated power)	
Power factor at Rated power / Adjustable power factor	> 0.99 / 0.8 leading to 0.8 lagging	
Feed-in phases/connection phases	3 / 3 - N - PE	
Backup data (on grid mode)		
Max. output power for backup load	43000W	
Max. output current for back- up load	3*63A (25°C)	
Backup data (off-grid mode)		
Rated voltage	3 / N / PE, 220 / 380 V; 230 / 400 V; 240 / 415 V (± 2 %)	
Rated frequency	50Hz / 60Hz (± 0.2 %)	
THDV(@Linear load)	< 2%	
Backup switch time	<10ms	
Rated output power	5000 W / 5000 VA	6000 W / 6000 VA
Peak output power ***	10000 W / 10000 VA, 10s	12000 W / 12000 VA, 10s
Efficiency		
Max. efficiency / European efficiency	97.9 % / 97.2 %	97.9% / 97.3 %
Protection & Function		
Grid monitoring	Yes	
DC reverse polarity protection	Yes	
AC short-circuit protection	Yes	
Leakage current protection	Yes	
DC switch (solar)	Yes	
Surge Protection	DC Type II / AC Type II ****	
PID Zero	Yes	
Battery input reverse polarity protection	Yes	
General Data		
Topology (solar / battery)	Transformerless / Transformerless	
Degree of protection	IP65	
Dimensions (W x H x D)	620 * 480 * 195 mm	

Parameters	SH5T	SH6T
Weight	32kg	
Mounting method	Wall-mounting bracket	
Operating ambient temperature range	-25 °C - 60 °C	
Allowable relative humidity range(Non-condensing)	0% - 100%	
Cooling method	Natural convection	
Max. operating altitude	2000m	
Noise (Typical)	35dB(A)	
Display	LED	
Communication	RS485, WLAN, Ethernet, CAN	
DI / DO	DI * 4 / DO * 2 / DRM0	
DC connection type	MC4 compatible connector (PV, Max.6mm ²) / Plug and play connector (battery, Max.10mm ²)	
AC connection type	Plug and play connector (Max.16mm ²)	
Country of manufacture	China	

* Input voltage exceeding the MPPT operating voltage range triggers inverter protection.

** Depending on the connected battery.

*** Can be reached only if PV and battery power is sufficient.

**** Only when the DC switch is set to "ON", the DC Type II is able to provide effective protection against electrical surges.

Note: The output voltage of strings should all exceed the lower limit of the full load MPPT voltage range.

Parameters	SH8T	SH10T
Input (DC)		
Recommended max. PV input power	16000 Wp	20000 Wp
Max. PV input voltage*	1000 V	
Min. PV input voltage / Start-up input voltage	150 V / 180 V	
Rated PV input voltage	600 V	
MPPT operating voltage range	150 V - 950 V	
MPP voltage range for rated power	355 V - 850 V	300 V - 850 V
No. of independent MPP trackers	2	

Parameters	SH8T	SH10T
No. of PV strings per MPPT	1 / 1	2 / 1
Max. PV input current	32 A (16 A / 16 A)	48 A (32 A / 16 A)
Max. DC short-circuit current	40 A (20 A / 20 A)	60 A (40 A / 20 A)
Max. current for input connector	30 A	
Battery Data		
Battery type	Li-ion battery	
Battery voltage	100 V - 700 V	
Max. charge / discharge current**	50 A / 50 A	
Max. charge / discharge power	15000 W / 8000 W	15000 W / 10000 W
Input and Output (AC)		
Max. AC power from grid	43000 VA	
Rated AC output power	8000 W	10000 W 9999W for Australia
Max. AC output apparent power	8000 VA	10000 VA 9999VA for Australia
Max. AC output current	12.1 A	15.2 A
Rated AC voltage	3 / N / PE, 220 / 380 V; 230 / 400 V; 240 / 415 V	
AC voltage range	270 - 480 V	
Rated grid frequency	50 / 60Hz	
Grid frequency range	45 - 55Hz / 55 - 65Hz	
Harmonic (THD)	<3% (of rated power)	
Power factor at Rated power / Adjustable power factor	> 0.99 / 0.8 leading to 0.8 lagging	
Feed-in phases/connection phases	3 / 3 - N - PE	
Backup data (on grid mode)		
Max. output power for backup load	43000W	
Max. output current for back-up load	3*63A (25°C)	
Backup data (off-grid mode)		
Rated voltage	3 / N / PE, 220 / 380 V; 230 / 400 V; 240 / 415 V (± 2 %)	
Rated frequency	50Hz / 60Hz (± 0.2 %)	
THDV(@Linear load)	< 2%	
Backup switch time	<10ms	

Parameters	SH8T	SH10T
Rated output power	8000 W / 8000 VA	10000 W / 10000 VA
Peak output power ***	13500 W / 13500 VA, 10s	15000 W / 15000 VA, 10s
Efficiency		
Max. efficiency / European efficiency	98.0 % / 97.4 %	98.0% / 97.5 %
Protection & Function		
Grid monitoring		Yes
DC reverse polarity protection		Yes
AC short-circuit protection		Yes
Leakage current protection		Yes
DC switch (solar)		Yes
Surge Protection	DC Type II / AC Type II ****	
PID Zero		Yes
Parallel operation on grid port	Master-slave mode	
Battery input reverse polarity protection		Yes
General Data		
Topology (solar / battery)	Transformerless / Transformerless	
Degree of protection	IP65	
Dimensions (W x H x D)	620 * 480 * 195 mm	
Weight	32kg	
Mounting method	Wall-mounting bracket	
Operating ambient temperature range	-25 °C - 60 °C	
Allowable relative humidity range(Non-condensing)	0% - 100%	
Cooling method	Natural convection	
Max. operating altitude	2000m	
Noise (Typical)	35dB(A)	
Display	LED	
Communication	RS485, WLAN, Ethernet, CAN	
DI / DO	DI * 4 / DO * 2 / DRM0	
DC connection type	MC4 compatible connector (PV, Max.6mm ²) / Plug and play connector (battery, Max.10mm ²)	
AC connection type	Plug and play connector (Max.16mm ²)	
Country of manufacture	China	

* Input voltage exceeding the MPPT operating voltage range triggers inverter protection.

** Depending on the connected battery.

*** Can be reached only if PV and battery power is sufficient.

**** Only when the DC switch is set to "ON", the DC Type II is able to provide effective protection against electrical surges.

Note: The output voltage of strings should all exceed the lower limit of the full load MPPT voltage range.

Parameters	SH12T	SH15T
Input (DC)		
Recommended max. PV input power	24000 Wp	30000 Wp
Max. PV input voltage*	1000 V	
Min. PV input voltage / Start-up input voltage	150 V / 180 V	
Rated PV input voltage	600 V	
MPPT operating voltage range	150 V - 950 V	
MPP voltage range for rated power	355 V - 850 V	335 V - 850 V
No. of independent MPP trackers	2	3
No. of PV strings per MPPT	2 / 1	2 / 2 / 1
Max. PV input current	48 A (32 A / 16 A)	80 A (32 A / 32 A / 16 A)
Max. DC short-circuit current	60 A (40 A / 20 A)	100 A (40 A / 40 A / 20 A)
Max. current for input connector	30 A	
Battery Data		
Battery type	Li-ion battery	
Battery voltage	100 V - 700 V	
Max. charge / discharge current**	50 A / 50 A	
Max. charge / discharge power	15000 W / 12000 W	30000 W / 15000 W
Input and Output (AC)		
Max. AC power from grid	43000 VA	
Rated AC output power	12000 W	15000 W
Max. AC output apparent power	12000 VA	15000 VA
Max. AC output current	18.2 A	22.8 A

Parameters	SH12T	SH15T
Rated AC voltage	3 / N / PE, 220 / 380 V; 230 / 400 V; 240 / 415 V	
AC voltage range	270 - 480 V	
Rated grid frequency	50 / 60Hz	
Grid frequency range	45 - 55Hz / 55 - 65Hz	
Harmonic (THD)	<3% (of rated power)	
Power factor at Rated power / Adjustable power factor	> 0.99 / 0.8 leading to 0.8 lagging	
Feed-in phases/connection phases	3 / 3 - N - PE	
Backup data (on grid mode)		
Max. output power for backup load	43000W	
Max. output current for back- up load	3*63A (25°C)	
Backup data (off-grid mode)		
Rated voltage	3 / N / PE, 220 / 380 V; 230 / 400 V; 240 / 415 V (± 2 %)	
Rated frequency	50Hz / 60Hz (± 0.2 %)	
THDV(@Linear load)	< 2%	
Backup switch time	<10ms	
Rated output power	12000 W / 12000 VA	15000 W / 15000 VA
Peak output power ***	16800 W / 16800 VA,10s	25500 W / 25500 VA,10s
Efficiency		
Max. efficiency / European efficiency	98.0 % / 97.5 %	98.1% / 97.6 %
Protection & Function		
Grid monitoring	Yes	
DC reverse polarity protection	Yes	
AC short-circuit protection	Yes	
Leakage current protection	Yes	
DC switch (solar)	Yes	
Surge Protection	DC Type II / AC Type II ****	
PID Zero	Yes	
Parallel operation on grid port	Master-slave mode	
Battery input reverse polarity protection	Yes	
General Data		
Topology (solar / battery)	Transformerless / Transformerless	

Parameters	SH12T	SH15T
Degree of protection	IP65	
Dimensions (W x H x D)	620 * 480 * 195 mm	620 * 480 * 245 mm
Weight	32kg	38kg
Mounting method	Wall-mounting bracket	
Operating ambient temperature range	-25 °C - 60 °C	
Allowable relative humidity range(Non-condensing)	0% - 100%	
Cooling method	Natural convection	
Max. operating altitude	2000m	
Noise (Typical)	35dB(A)	
Display	LED	
Communication	RS485, WLAN, Ethernet, CAN	
DI / DO	DI * 4 / DO * 2 / DRM0	
DC connection type	MC4 compatible connector (PV, Max.6mm ²) / Plug and play connector (battery, Max.10mm ²)	
AC connection type	Plug and play connector (Max.16mm ²)	
Country of manufacture	China	

* Input voltage exceeding the MPPT operating voltage range triggers inverter protection.

** Depending on the connected battery.

*** Can be reached only if PV and battery power is sufficient.

**** Only when the DC switch is set to "ON", the DC Type II is able to provide effective protection against electrical surges.

Note: The output voltage of strings should all exceed the lower limit of the full load MPPT voltage range.

Parameters	SH20T	SH25T
Input (DC)		
Recommended max. PV input power	40000 Wp	50000 Wp
Max. PV input voltage*	1000 V	
Min. PV input voltage / Start-up input voltage	150 V / 180 V	
Rated PV input voltage	600 V	
MPPT operating voltage range	150 V - 950 V	
MPP voltage range for rated power	355 V - 850 V	445 V - 850 V

Parameters	SH20T	SH25T
No. of independent MPP trackers	3	
No. of PV strings per MPPT	2 / 2 / 1	
Max. PV input current	80 A (32 A / 32 A / 16 A)	
Max. DC short-circuit current	100 A (40 A / 40 A / 20 A)	
Max. current for input connector	30 A	
Battery Data		
Battery type	Li-ion battery	
Battery voltage	100 V - 700 V	
Max. charge / discharge current**	50 A / 50 A	
Max. charge / discharge power	30000 W / 20000 W	30000 W / 25000 W
Input and Output (AC)		
Max. AC power from grid	43000 VA	
Rated AC output power	20000 W	25000 W
Max. AC output apparent power	20000 VA	25000 VA
Max. AC output current	30.4 A	37.9 A
Rated AC voltage	3 / N / PE, 220 / 380 V; 230 / 400 V; 240 / 415 V	
AC voltage range	270 - 480 V	
Rated grid frequency	50 / 60Hz	
Grid frequency range	45 - 55Hz / 55 - 65Hz	
Harmonic (THD)	<3% (of rated power)	
Power factor at Rated power / Adjustable power factor	> 0.99 / 0.8 leading to 0.8 lagging	
Feed-in phases/connection phases	3 / 3 - N - PE	
Backup data (on grid mode)		
Max. output power for backup load	43000W	
Max. output current for back-up load	3*63A (25°C)	
Backup data (off-grid mode)		
Rated voltage	3 / N / PE, 220 / 380 V; 230 / 400 V; 240 / 415 V (± 2 %)	
Rated frequency	50Hz / 60Hz (± 0.2 %)	
THDV(@Linear load)	< 2%	

Parameters	SH20T	SH25T
Backup switch time	<10ms	
Rated output power	20000 W / 20000 VA	25000 W / 25000 VA
Peak output power ***	32000 W / 32000 VA, 10s	36500 W / 36500 VA, 10s
Efficiency		
Max. efficiency / European efficiency	98.1% / 97.6 %	98.2% / 97.8 %
Protection & Function		
Grid monitoring	Yes	
DC reverse polarity protection	Yes	
AC short-circuit protection	Yes	
Leakage current protection	Yes	
DC switch (solar)	Yes	
Surge Protection	DC Type II / AC Type II ****	
PID Zero	Yes	
Parallel operation on grid port	Master-slave mode	
Battery input reverse polarity protection	Yes	
General Data		
Topology (solar / battery)	Transformerless / Transformerless	
Degree of protection	IP65	
Dimensions (W x H x D)	620 * 480 * 245 mm	
Weight	38kg	40kg
Mounting method	Wall-mounting bracket	
Operating ambient temperature range	-25 °C - 60 °C	
Allowable relative humidity range(Non-condensing)	0% - 100%	
Cooling method	Natural convection	Fan cooling
Max. operating altitude	2000m	
Noise (Typical)	35dB(A)	50dB(A)
Display	LED	
Communication	RS485, WLAN, Ethernet, CAN	
DI / DO	DI * 4 / DO * 2 / DRM0	
DC connection type	MC4 compatible connector (PV, Max.6mm ²) / Plug and play connector (battery, Max.10mm ²)	
AC connection type	Plug and play connector (Max.16mm ²)	
Country of manufacture	China	

* Input voltage exceeding the MPPT operating voltage range triggers inverter protection.

** Depending on the connected battery.

*** Can be reached only if PV and battery power is sufficient.

**** Only when the DC switch is set to "ON", the DC Type II is able to provide effective protection against electrical surges.

Note: The output voltage of strings should all exceed the lower limit of the full load MPPT voltage range.

11.2 The Compatibility for Backup under Off-grid Scenario

The information below is about the compatibility for backup of SUNGROW SH15/20/25T inverter under off-grid scenario. Please refer to this information before you use the back-up model of the four inverters under off-grid situation.

SUNGROW SBR160:

Type	Load Power		
	SH15T	SH20T	SH25T
Dust collector	2.4 kW	2.4 kW	2.4 kW
Water heater / Kettle / Iron / Oven / Toaster / Geother- mal blanket / Rice cooker	9 kW	9 kW	9 kW
Microwave oven	2.4 kW	2.4 kW	2.4 kW
Refrigerator	2.4 kW	2.4 kW	2.4 kW
TV / Computer	9 kW	9 kW	9 kW
Bath heater	2.4 kW	2.4 kW	2.4 kW
Fluorescent / LED lights	9 kW	9 kW	9 kW
Electric fan / Ceiling fan	2.4 kW	2.4 kW	2.4kW
Conditioner (Frequency conversion)	3P	3P	3P

SUNGROW SBH150:

Type	Load Power		
	SH15T	SH20T	SH25T
Dust collector	2 kW	2 kW	2 kW
Water heater / Kettle / Iron / Oven / Toaster / Geother- mal blanket / Rice cooker	10 kW	10 kW	10 kW
Microwave oven	2 kW	2 kW	2 kW
Refrigerator	2 kW	2 kW	2 kW
TV / Computer	10 kW	10 kW	10 kW
Bath heater	2 kW	2 kW	2 kW
Fluorescent / LED lights	10 kW	10 kW	10 kW

Type	Load Power		
	SH15T	SH20T	SH25T
Electric fan / Ceiling fan	2 kW	2 kW	2kW
Conditioner (Frequency conversion)	3P	3P	3P

For those loads that not covered in this document, please contact SUNGROW to make sure the compatibility of the specific loads under off-grid scenario. SUNGROW will not be held responsible for the usage of any load without confirmation. We will keep updating this document, please contact SUNGROW if there are any relevant issues.

11.3 Quality Assurance

When product faults occur during the warranty period, SUNGROW will provide free service or replace the product with a new one.

Evidence

During the warranty period, the customer shall provide the product purchase invoice and date. In addition, the trademark on the product shall be undamaged and legible. Otherwise, SUNGROW has the right to refuse to honor the quality guarantee.

Conditions

- After replacement, unqualified products shall be processed by SUNGROW.
- The customer shall give SUNGROW a reasonable period to repair the faulty device.

Exclusion of Liability

In the following circumstances, SUNGROW has the right to refuse to honor the quality guarantee:

- The free warranty period for the whole machine/components has expired.
- The device is damaged during transport.
- The device is incorrectly installed, refitted, or used.
- The device operates in harsh conditions beyond those described in this manual.
- The fault or damage is caused by installation, repairs, modification, or disassembly performed by a service provider or personnel not from SUNGROW.
- The fault or damage is caused by the use of non-standard or non-SUNGROW components or software.
- The installation and use range are beyond stipulations of relevant international standards.
- The damage is caused by unexpected natural factors.

For faulty products in any of above cases, if the customer requests maintenance, paid maintenance service may be provided based on the judgment of SUNGROW.

11.4 Contact Information

In case of questions about this product, please contact us.

We need the following information to provide you the best assistance:

- Model of the device
- Serial number of the device
- Fault code/name
- Brief description of the problem

For detailed contact information, please visit: <https://en.sungrowpower.com/contactUS>